



Newsletter

Simulation Based Engineering & Sciences

Year

15

n°3 Autumn 2018



Crashworthiness design of a train based on European Standard EN15227

Thermal Optimisation of **e-Drives** Using Moving **Particle Semi-implicit (MPS) Method**

3D-Simulation Enhances Product Development for **Positive Displacement Machines**

Augmented, Mixed and Virtual Reality in Engineering **Disruptive or Innovative?**

Strains and Load reconstruction of **two-wheeled Scooters**

Helping engineers in the **Green Technology** industry overcome their design challenges

The Challenges of Creating User Interfaces for **Mass Market Devices**

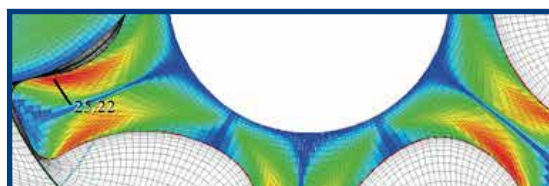

Contents

Interview

- 4 CAE's pivotal role in innovation

Case Histories

- 5 Crashworthiness design of a train based on European Standard EN15227
- 8 Thermal Optimisation of e-Drives Using Moving Particle Semi-implicit (MPS) Method
- 15 Helping engineers in the Green Technology industry overcome their design challenges
- 18 Strains and Load reconstruction of two-wheeled Scooters
- 20 3D-Simulation Enhances Product Development for Positive Displacement Machines
- 23 Augmented, Mixed and Virtual Reality in Engineering – Disruptive or Innovative?
- 26 The Challenges of Creating User Interfaces for Mass Market Devices
- 29 The practicalities of virtual system analysis
- 33 Ergonomic simulation – investing in greater company competitiveness and improved productivity

Research & Technology Transfer

- 36 EnginSoft and the European Space Agency investigate hydroponic plant growth for future space missions

Software Update

- 38 ANSYS 19.0: Cybernet Multiscale Analysis System (CMAS)
- 40 ANSYS CFD Release 19.2 expands user capabilities for product design
- 42 ANSYS Chemkin Enterprise: all the tools for reaction flow simulations in a single license
- 43 Using a 1D-3D co-simulation of a hydraulic pump failure to measure the pressure surge in a 2km pipeline
- 44 Improved Fatigue Prediction for Rotating Components
- 46 CAESSES: CAD for Automated Design Studies with Simulation Tools
- 48 CAE Software Reinvented for the Cloud
- 49 PASS/INSULATION and PASS/RELIEF to join PASS Suite
- 49 PSRE Co. Announces a New Version of PASS/HYDROSYSTEM
- 50 Modularization, democratization and standardization: the ESTECO technologies roadmap

News

- 51 EnginSoft USA, LLC is new distributor partner of FunctionBay, Inc. in North America
- 52 Global competition for engineering students to design a hybrid microgrid
- 53 Shortlist published for the soon-to-be-established Italian Highly-Specialized Competence Centers for Industry 4.0
- 54 Tolerance Management Sector sees creation of TTC3 GmbH "2.0"
- 54 Flownex Europe to launch at the 2018 International CAE Conference
- 55 Successful joint PSRE-EnginSoft booth at global process industry expo AICHEMA 2018
- 56 DatapointLabs Joins Applus+, a global testing, inspection and certification group
- 57 Open Innovation Challenge to support the adoption of Computer-Aided Engineering for Additive Manufacturing
- 59 International 2018 CAE Conference to host a ReCaM Project exploitation event

Newsletter EnginSoft Year 15 n°3 - Autumn 2018

To receive a free copy of the next EnginSoft Newsletters, please contact our Marketing office at: info@enginsoft.it

All pictures are protected by copyright. Any reproduction of these pictures in any media and by any means is forbidden unless written authorization by EnginSoft has been obtained beforehand. ©Copyright EnginSoft Newsletter.

EnginSoft S.p.A.

24126 BERGAMO c/o Parco Scientifico Tecnologico
Kilometro Rosso - Edificio A1, Via Stezzano 87
Tel. +39 035 368711 • Fax +39 0461 979215
50127 FIRENZE Via Panciatichi, 40
Tel. +39 055 4376113 • Fax +39 0461 979216
35129 PADOVA Via Giambellino, 7
Tel. +39 049 7705311 • Fax +39 0461 979217
72023 MESAGNE (BRINDISI) Via A. Murri, 2 - Z.I.
Tel. +39 0831 730194 • Fax +39 0461 979224
38123 TRENTO fraz. Mattarello - Via della Stazione, 27
Tel. +39 0461 915391 • Fax +39 0461 979201
10133 TORINO Corso Marconi, 10
Tel. +39 011 6525211 • Fax +39 0461 979218

www.enginsoft.it - www.enginsoft.com
e-mail: info@enginsoft.it

*The EnginSoft Newsletter is a quarterly magazine
published by EnginSoft SpA*

COMPANY INTERESTS

EnginSoft GmbH - Germany
EnginSoft UK - United Kingdom
EnginSoft France - France
EnginSoft Nordic - Sweden
EnginSoft Turkey - Turkey
VSA-TTC3 - Germany
www.enginsoft.com

CONSORZIO TCN www.consorziotcn.it • www.improve.it
SimNumerica www.simnumerica.it
M3E Mathematical Methods and Models for Engineering www.m3eweb.it

ASSOCIATION INTERESTS

NAFEMS International www.nafems.it • www.nafems.org
TechNet Alliance www.technet-alliance.com

ADVERTISEMENT

For advertising opportunities, please contact our Marketing office at: info@enginsoft.it

RESPONSIBLE DIRECTOR

Stefano Odorizzi

PRINTING

Grafiche Dalpiaz - Trento

The EnginSoft Newsletter editions contain references to the following products which are trademarks or registered trademarks of their respective owners: ANSYS, ANSYS Workbench, AUTODYN, CFX, FLUENT, FORTE, SpaceClaim and any and all ANSYS, Inc. brand, product, service and feature names, logos and slogans are registered trademarks or trademarks of ANSYS, Inc. or its subsidiaries in the United States or other countries. [ICEM CFD is a trademark used by ANSYS, Inc. under license]. (www.ANSYS.com) - modeFRONTIER is a trademark of ESTECO Spa (www.esteco.com) - Flownex is a registered trademark of M-Tech Industrial - South Africa (www.flownex.com) - MAGMASOFT is a trademark of MAGMA GmbH (www.magmasoft.de) - FORGE, COLDFORM and FORGE Nxt are trademarks of Transvalor S.A. (www.transvalor.com) - LS-DYNA is a trademark of LSTC (www.lstc.com) - Cetol 6σ is a trademark of Sigmetrix L.L.C. (www.sigmetrix.com) - RecurDyn™ and MBD for ANSYS is a registered trademark of FunctionBay, Inc. (www.functionbay.org) - Maplesoft are trademarks of Maplesoft™, a subsidiary of Cybernet Systems Co. Ltd. in Japan (www.maplesoft.com)

FLASH



PriceWaterhouseCoopers (PwC)'s last Global Industry 4.0 survey, published in 2016, found that global producers of industrial products will invest US\$907-bn per year -- or 5% per year of annual revenue -- until 2020 on gearing up for Industry 4.0 to take advantage of operational cost-savings and improved efficiency. 72% of German manufacturers surveyed by Ernst and Young for its Industry 4.0: Status Quo and Perspectives study, published in November 2017, cited process optimization resulting from greater flexibility as being their most important driver for the adoption of so-called "Industry 4.0 applications".

These same survey participants cited the costs and the shortage of skilled people, as being obstacles to the transformation of their organizations. The inability to source the range of technical and strategic skills required to enable and realize the transformation to Industry 4.0 is something that companies and governments across the world are struggling with. Germany is generally held to have the most effective model of technical and vocational training to meet industry requirements and many governments are trying to emulate its model for work-orientated and work-based training.

There are also other ways to address this skills shortage. One is to outsource specific projects or objectives to a service provider such as EnginSoft that is a leader in technology and industry skills transfer, while also offering to flank in-house teams to provide on-the-job training, mentoring and shadowing. Another way is to put key staff through specialised advanced training programmes, another service offered by EnginSoft. A third is to take full advantage of industry events that bring together research, academia and leaders from different sectors of industry, all with a common focus.

The 2018 International CAE Conference, now in its 34th year, is exactly such an initiative. It will expose its participants to the latest innovations and approaches – from ground breaking technology disruptors, to iterative approaches to transforming existing production facilities into the factories of the future. Attendees will have the ability to interrogate detailed case studies and explore leading-edge global and European innovations. It is a must-attend event for anyone who wants their organization not just to survive, but to thrive, as we inexorably move into this new era. Ongoing focused reading is another important way to keep abreast of developments across the board. Sometimes just reading about an application of CAE or simulation in one industry can spark a break-through thought as to how it could be applied in another, unrelated sector.

This issue of the EnginSoft newsletter provides exactly that variety: from a case study from Hitachi Rail on the development of a process for performing crashworthiness analyses for international standards-compliance, to making a case for the use of virtual system models for testing the design reliability of hydraulic systems; from looking in-depth at the practicalities of virtual system analysis, to examining the innovative and disruptive ways that augmented, mixed and virtual reality can be applied in engineering; from how CAE can be used to improve the worker ergonomics of manufacturing or assembly lines to enable greater productivity and worker wellbeing, to how CAE software is being reinvented for the Cloud, there is plenty of food for thought and material to study as we wait for October. The 2018 International CAE Conference should prove to be just as varied, and interesting, providing much to ponder and many invaluable opportunities to deepen your industry and technical knowledge. I look forward to seeing you there!

Stefano Odorizzi, Editor in chief

A handwritten signature in black ink, appearing to read 'Stefano Odorizzi'.

CAE's pivotal role in innovation

Interview with Umberto Lecci of Elettronica Group, a world leader in Electronic Warfare solutions



In this interview, Umberto Lecci, head of the Thermo-Mechanical Engineering Design Solution Department of Elettronica Group, a world leader with a complete portfolio of state-of-the-art electronic warfare solutions for modern operational scenarios, discusses the pivotal role that Computer Assisted Engineering plays in innovation which is becoming vital to companies' survival and success in today's fast-paced competitive world markets .



Q: What role does innovation plan (and should it play) in the defence sector?

A: Innovation, in technology and processes, is fundamental for any company that wants to position itself as an industry leader. In fact, it is only by being innovative that companies can survive in a progressively competitive world, where customer demands become increasingly challenging and competition more and more fierce. This is even more true for a company like ELT which has always welcomed and satisfied its customers' requests.

Q: What are the important strategies for innovation and which assessments do you use to drive innovation?

A: It is important to keep abreast of developments with the various tools and with the technological and product processes in your industry. Equally important is to focus both on young staff members, continuously encouraging them to be innovative, as well as on your mature staff members who are the real custodians of company know-how that must be handed down if it is not to be lost.

Q: What role do CAE and virtual prototyping tools play in this regard? How have user needs changed in recent years?

A: These tools are an integral part of development processes and are fundamental to design optimization, in terms of:

- Time
- Costs
- Quality
- Compliance with requirements

As the market daily becomes more dynamic and faster, these tools are evolving to support design. The exponential growth in computing power, and the fact that we work in a market that is steadily shortening timeframes to get to market first, mean that

virtual prototyping is increasingly becoming a necessity in design. When it is linked to a valid and up-to-date database, it allows designers to evaluate the alternatives that then imply design choices.

Q. During your professional experience, what benefits have you gained and how has this changed your approach to design and production?

CAE modeling and its continuous evolution means that, during the design phase, engineers can so confidently project the behaviour of products in advance that they can then focus

on reducing any potential problems arising from the process (identified during the qualification or test phases). Furthermore, making greater use of virtual prototyping together with experimental results, enables engineers to reliably and confidently identify and validate viable design solutions at the beginning of the design cycle, during the design phase.

Q. What prospects do you see for scientific programming applications in relation to the challenges posed by the future?

They will become progressively indispensable, even more so if they could be integrated into CAD modelers and a departmental PDM system capable of managing, maintaining and sharing the various analysis runs and their results.

Q. What projects, objectives and new goals do you intend to pursue thanks to the use of these tools?

We will be creating increasingly accurate numerical designs, together with databases to allow increasingly "robust" and complete virtual prototyping, and the integration of simulation systems with a departmental PDM (Product Data Management) system.

Q. What are your hopes for the world of scientific technology in its constant search for a dimension between creativity and competitiveness?

I hope to see better integration between solvers and software, even from different production companies. I also hope to see the introduction of more robust solvers that are able to guide designers in their choices both during data processing and the post-processing of data.



Crashworthiness design of a train based on European Standard EN15227

Description of the numerical/experimental methodology applied to the new Metro Light Automatic (MLA) platform project

Modern trains must not only fulfil traditional static load and fatigue requirements, but also passive safety necessities. These crashworthiness requirements must all be considered in the design of the structural part of the coach.

Sophisticated crashworthiness analyses today are a regular step in the engineering process of developing a new train. A vehicle crash is a dynamic phenomenon featuring a complex interaction between structural and inertial behavior. It is generally recognized that in a typical collision, the end structure first experiences the impact and then undergoes large deformation in the impact region. The passengers only later experience the effect of the impact. The first phenomenon is normally referred to as the primary collision and the second, related to the passengers, is normally referred to as the secondary collision.

Due to the geometrical complexities of rail vehicle structures and to the complicated material behavior involved in large deformation, finite element computer programs with elastoplastic dynamic analysis capabilities have to be used (LS-Dyna). This article describes the methodology that was adopted in the analysis and design of the structural crashworthiness of rail vehicles: the project led to the development of new products with new technologies using innovative approaches and materials.

The main goal of the project was to make the vehicle compliant with the current European Standard (EN15227) for Crashworthiness by means of a re-

design of the structural strength. This was made even more complex by the presence of the aesthetic and mechanical interface restraints linked to the “Platform” concept. In particular for this project, the sacrificial elements designed for placement in the impact region are innovative because they have been made from a special composite material that combines the qualities of lightness, efficiency and low cost.

The aim of this article is to describe the crashworthiness design process for the new Metro Light Automatic (MLA) platform project that was carried out by Hitachi Rail Italy, according to the EN15227 standard. This process was carried out following the steps described by the standard.

The new MLA platform belongs to category C-II as defined by the EN15227 standard, which requires that the crash behavior of the train be verified during the following scenario: a symmetrical collision at a relative speed of 25 km/h between two identical trains with 40 mm of vertical offset.

The elements of the new MLA platform that are specifically involved in absorbing this energy are the front absorbers placed in front of the cab structure (Figure 1). These critical elements are made of a special composite material developed to respect the fire and smoke regulations too.

Hitachi Rail Italy’s validation process

The whole crashworthiness design process of the vehicle has been summarized in Figure 2. The process consists of numerical calculation phases and special



Fig. 1 - Front cab layout

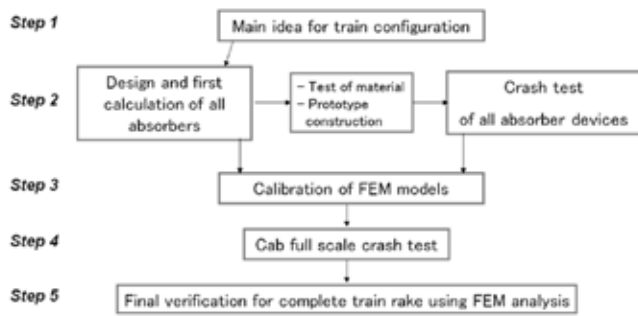

Fig. 2 - Crashworthiness design process

tests dedicated to each step that are useful to validate the Finite Element Method (FEM) models developed.

Step 1

In this phase of the project, all the possible configurations of the absorber elements were investigated. At the end of this stage, the final configuration (in terms of load, stroke and energy dissipated) of the absorber elements is defined. During this step, each part of the vehicle is represented by means of spring elements and lumped masses. This representation (a 1D FEM model) is used to allow an effective and immediate evaluation of both the behavior of the train during a crash and of the soundness of the solutions. The LS-DYNA software made it possible to obtain good results using the *ELEMENT_DISCRETE associated with material card S-06 (*MAT_SPRING_GENERAL_NON_LINEAR).

Step 2

After freezing the main characteristics of the absorber devices in terms of load, stroke and energy dissipated, Step 2 and Step 3 respectively aimed to virtually design and experimentally validate the absorber.

Many design unknowns, such as the composite material's mechanical behavior, ply-up and overall dimensions are directly involved in the design phase and hence the virtual simulation becomes an asset to speed up the design process.

Specifically, the main goal of Step 2 was to numerically build up an energy absorber model that was able to reproduce the experimental results in terms of the impact force versus the crushing distance, as defined in Step 1. Hence, the mechanical behavior of the composite material and the cohesiveness between the layers had to be characterized. To do so, an experimental testing campaign was conducted to obtain the necessary data to generate the material cards in LS-DYNA. The *MAT_58 (*MAT_LAMINATED_COMPOSITE_FABRIC) card was used for the composite material, while *MAT_138 (*MAT_COHESIVE_MIXED_MODE) was used for the cohesive behavior.

A summary of the experimental tests used for numerically calibrating the material behavior are described hereunder:

- Composite material (*MAT_58) - The mechanical properties of the composite material were investigated at different fiber orientations

by means of both tensile and compression tests (0,45,90°).

- Cohesive material (*MAT_138) - The mechanical properties of the bonding between plies was characterized by means of two tests: a Double Cantilever Beam (DCB) and an End Notched Flexure (ENF).

Composite material

Tensile and compression coupons were modeled according to the experimental tested samples.

Cohesive material

Once the base material was characterized in terms of its elastic and failure properties, the next step was to characterize the bonding between the composite plies. Most of LS-DYNA material models implement the fracture mechanics "Cohesive Zone Modeling" (CZM) approach, therefore, the user has to identify several parameters concerning fracture mode I (opening) and mode II (shear).

For these simulations, the simplest and most commonly-used material model in cohesive zone modeling, the *MAT_138 (linear elastic with

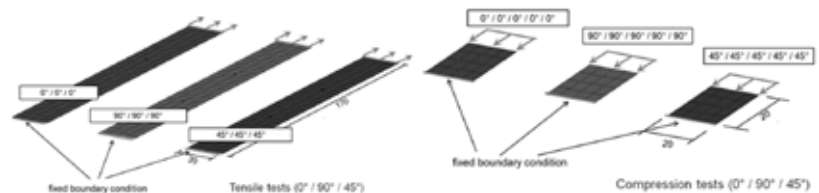

Fig. 3 - Simulated tensile and compression tests coupons with LS-DYNA.

linear softening), was used. On the other hand, the bonding between the plies was explicitly modeled using solid cohesive elements (ELFORM= 20).

The Mode I parameters were calibrated using a DCB test. The composite layout consists of a stack of several layers that are longitudinally oriented at 0° with an initial aperture (crack). The aim of the DCB test is to apply mode I tension at the layer's interface. Force versus displacement is recorded. As a further step, a regularization method was applied to reduce the spurious mesh dependence in the model. The Mode II parameters were calibrated using an ENF test. As for the previous case, the composite layout consisted of a stack of several layers longitudinally oriented at 0° with an initial crack opening.

Once the mechanical properties of the composite and bonding layers were defined, the numerical calculations of the FEM energy absorber could be executed. Here, the main challenge was to define an initial

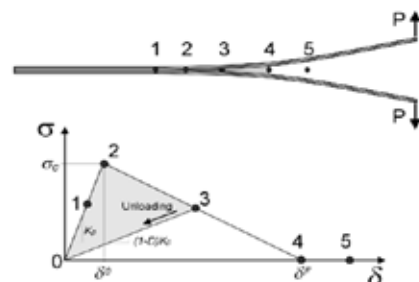

Fig. 4 - Example: Mode I (opening) showing the linear elastic with linear softening of the cohesive material.

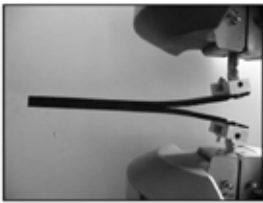

Fig. 5 – DCB Mode I (opening) experimental test and overview of numerical modeling.

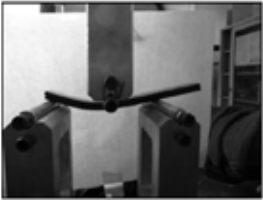
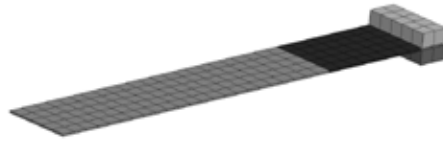
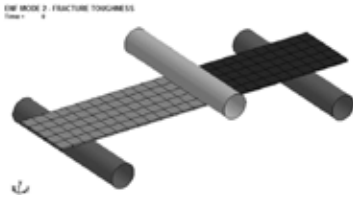

Fig. 6 - ENF Mode II (opening) experimental testing and respective FE model.



ply-up design and the overall dimensions of the absorber while keeping in mind the project requirements in terms of force profile and energy absorption (Step 1).

The pre-processing operations (the creation of the FEM model, materials, contacts, boundary conditions etc.) were carried out with LS-Prepost_4.3. The solver used was LS-DYNA MPP 9.1.0 64-bit for Linux, the post processor LS-Prepost_4.3.

Step 3

The FEM model of the absorber built-up in the Step 2 was experimentally tested and numerically validated in this design step. As a matter of fact, it took several virtual design iterations to come up with a design option that was ready for the prototyping. Some of the numerical parameters that were studied included the ply-up and the fiber orientation. The test consisted of 1 vs 1 absorber impact. The simulations were performed in accordance with the experimental set up. The absorbers were positioned to create a vertical offset between the longitudinal axis of both components, as required by EN15227. The reliability of the calibrated material data and of the FE model from Step 2 was confirmed by the experimental results.

Step 4

In “Step 4”, a full-scale crash test of the cab was conducted. The main purpose of this test on the first car was to validate the numerical model used in Step 3 in a real scenario and hence to correctly reproduce the energy absorbing collapse. The cab full-scale crash test is required to reflect the energy absorption requirements of the crash scenario requested by EN15227.

As in Steps 2 and 3, numerical simulations were used to predict the behavior of the event before the test. The calibrated FEM models of the

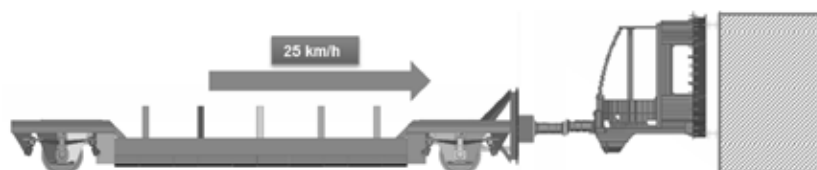

Fig. 7 - Cab full scale crash test layout

absorber devices (from Step 3) were used in the numerical simulations of this phase of the project.

Step 5

In Step 5, the whole-train FEM model was developed to simulate the crash scenario as required by EN15227. The requested scenario concerns a collision between two trains, the first one traveling at a speed of 25 km/h and the second one being stationary with no brake system engaged. In such a critical situation, the design of the passive safety system must ensure that the impact energy is properly dissipated without compromising the structural integrity of the cars.

The FEM model of the scenario was comprised of the following components:

- the validated FEM model of the front absorbers and the front cab structure (from Step 3 and Step 4);
- coaches “A” and “C”, modelled with 1D, 2D and 3D elements;
- the FEM model of the first three bogies;
- the remaining vehicles of the train unit were represented by means of a lumped mass/spring system representing their overall behavior (as requested by EN15227)

Conclusions

The main challenge of the current study was to design an innovative sacrificial element for energy absorption purposes in the railway industry. This component was made of a special composite material which combines the qualities of lightness, efficiency and low cost. The selected absorber configuration is the result of an extensive virtual study and experimental testing program that was aimed at fulfilling the homologation requirements prescribed by the EN 15227 standard. Simulation was used to speed up the design phase and to better understand the product performance. These key factors helped to reduce the number of prototypes required for testing.

Fig. 10 - Whole train FEM model and respective FE model.

Moreover, the virtual design process for the crashworthiness of a train as described in the previous pages was developed and has been consolidated into Hitachi Rail Italy. The process, followed step by step, allows the company to achieve design compliance with the EN 15227 standard since it respects and fulfills the following parameters:

- Average acceleration of the train vehicles below 5g.
- Survival space and structural integrity maintained for the occupied areas of the vehicle structure.
- Absence of significant plastic deformations in the passenger area.
- No overriding at the train unit extremities and between the vehicles.

Angelo Surini, Stefano Raiti,
Hitachi Rail Italy

David Blanco, Dario D'Agostino
EnginSoft



Thermal Optimisation of e-Drives Using Moving Particle Semi-implicit (MPS) Method



Abstract: A novel technique to model the temperature of windings in oil cooled e-machines has been developed. It aims to reduce the time taken to generate and solve thermal models by using a combination of particle based fluid modelling and steady state finite element (FE) thermal modelling. The fluid model is used to generate a heat transfer coefficient (HTC) map for the complex, multi-phase flow, which is applied to a finite element FE model of the e-machine. This would allow thermal modelling to take place at a concept design stage where rapid design iterations are required.

By using this combined modelling approach, it was shown that it is possible to generate and solve models in under a week which show credible results. Further correlation work is underway to validate the models and results predicted.

Keywords: MPS, e-machine thermal modelling, oil cooled e-machine, multi-phase flow.

1. Introduction

With major OEMs committing to increasing numbers of EVs and greater electrification, the total electric car stock could reach between 9 million and 20 million by 2020 (4). To make this possible, the UK's Advanced Propulsion Centre (APC) have outlined target costs, power

| Passenger Car Traction Motor ¹ | 2017 | 2025 | 2035 |
|-------------------------------------------|------|------|------|
| Cost (\$/kW) ² | 10 | 5.8 | 4.5 |
| Continuous power density (kW/kg) | 2.5 | 7 | 9 |
| Continuous power density (kW/l) | 7 | 25 | 30 |
| Drive cycle efficiency (%) ³ | 86.5 | 92.5 | 93 |

1) All assume 350V / 450Amps @ 65degC inlet

2) Prices are 300% mark-up on material costs

3) Drive cycle based on WLTP

Fig. 1 - APC Targets for Passenger Car Traction Motors (5)

densities and efficiencies for passenger vehicle traction e-machines, as shown in Figure 1 (5).

They also note that one key technological enabler is the closer integration of e-machines into transmissions and internal combustion engines (ICEs), and eventually fully integrated powertrains. This means that there will be a shared cooling and lubrication strategy within the transmission and e-machine, tending towards oil cooled e-machines. A passive (splash) lubrication regime is likely to maximise the efficiency of the integrated powertrain whilst minimising cost and weight but may not deliver sufficient cooling for high power density e-machines. Down-sized, low power electric pumps will be required to balance efficiency, mass and cooling.

With increasing power density motors, the loss density will also increase, meaning that more effective e-machine cooling will be required. Alongside more integration in powertrains, e-machine cooling becomes a factor in the lubrication design and it will become increasingly necessary to use fluid modelling to influence concept level designs.

Currently it is difficult to accurately model fluid flow within enclosed volumes such as transmissions and e-machines with traditional computational fluid dynamics (CFD) methods due to the high computation time required. It is even less practical to model heat dissipation as the bulk temperature stabilises over a much greater timescales than the fluid flow, meaning even greater computation time is required. As a result, it is currently impractical to perform in the early stages of a new design where rapid iterations are required. This is currently a barrier at the concept stage to the optimisation of oil cooled e-machines.

It has been shown that modelling oil within enclosed volumes with rotating components, such as transmissions, can be performed effectively on modest hardware (2) (6). This paper builds on this work to model multiphase fluid flow within an oil cooled e-machine.

By combining this approach with FE it is possible to model the temperature distribution in the windings of an oil cooled e-machine in a compressed timescale, enabling faster design iterations and more power dense e-machines through thermal optimisation.

2. Thermal Modelling

2.1 Modelling Oil Within Powertrains

To understand the movement of oil within powertrains there are two established methods which are practiced:

- Clear case testing
- Finite volume computational fluid dynamics (CFD) modelling

Baffles, oil guides and pumps can be tested in clear cases to optimise the oil distribution. High temperature testing is not possible however due to the limitations of the materials used for clear casings - typically transparent thermoplastics such as acrylic. The clear case testing is useful once a design has matured to the extent that the rotating components are relatively well defined but cannot provide useful data during the concept design phase. It can take several months to procure rotating components and so there is often a requirement to commit to a design for clear case testing at the same time as procuring prototype test components. As such, if any significant issue is found during clear case testing there is a large cost, both in lost time and wasted material, associated with re-design and re-testing.

Finite volume CFD is of limited benefit in the design of automotive transmissions or electrified powertrains due to the extended run time required to generate results. Typically it can take several weeks of computation to generate a few seconds of real world data. Fluid flow will tend to stabilise within a few seconds in a powertrain but it may take several minutes to reach thermal steady state (6). This could require months of simulation. As multiple input speeds would need to be modelled, it rapidly becomes impractical to use this type of CFD to model a single concept even on computers with high processing power.

An increasingly well correlated alternative method of CFD using particles is more suited to modelling fluids in confined volumes (2). This meshless CFD utilises a moving particle semi-implicit (MPS) method which allows simulation of single phase and multiphase fluid flow. With MPS the fluid is discretised as a series of particles whose interactions are calculated using conservation of momentum and mass. The Navier-Stokes equations are solved using the Lagrangian methodology (6). The MPS method is able to account for surface tension, droplet break up, free surface fragmentation and coalescence. Solid bodies are represented by mathematical functions, called distance functions, and so a mesh is not required. The MPS solver can be run on graphics processing units (GPUs) to further reduce computation time. This method enables much faster solving of fluid models, for example it can take as little as a few days to simulate several seconds of real time data for a single speed automotive transmission on modest hardware, compared to weeks using finite volume CFD.

Figure 2 shows a comparison of MPS vs CFD solve times for a simple automotive transmission. By combining the performance benefits of MPS with appropriate modelling simplifications, it may be possible to use this method as an iterative design tool, rather than a final validation.

| | Moving Particle Simulation | Mesh-Based CFD |
|----------------------------------------|-------------------------------------------------------------------|--------------------|
| Pre-process (geometry, meshing, setup) | < 1 day | 2 weeks |
| CPU Time | 5.0 [s] in 3 days | 0.5 [s] in 4 weeks |
| Cores | 12 | 32 |
| GPU Time | 5.0 [s] in 6 hours - v6 on K40 5.0 [s] in 3 hours - v6 on P100 | |

Fig. 2 - Comparison of MPS and CFD solve times for a simple automotive transmission (6)

2.2 Modelling Heat Transfer in Oil Cooled Motors

E-machine design software enables rapid iterations to develop high power density designs, with information on power curves and efficiency. A critical factor in increasing the power density of an e-machine is how much of the heat generated can be removed. Overheating can cause damage to the insulation and lead to short circuiting. The design of the cooling system will directly impact how much power the e-machine can produce in both continuous running and peak conditions.

There are several widely acknowledged and utilised methods for cooling E-machines in automotive transmissions:

- Water/glycol cooling jacket
- Direct oil spray onto the stator windings
- Oil or water/glycol in a hollow rotor shaft

The cooling effect of a water/glycol jacket can be calculated relatively easily as the channels are fully filled with water/glycol only. This means that correlations to empirical data is known to be accurate.

Oil sprayed directly onto the stator windings provides a greater challenge as the oil mixes with air in varying proportions over the entire surface of the windings. Empirical data is used to correlate to, however this is always a compromise as the data is inherently discontinuous, having been measured at a series of discrete points. As a result, the designs generated may not be as optimised as possible. By developing a more detailed method of modelling the temperatures on the surface of the e-machine windings it will be possible to increase its power density.

An MPS CFD method can be used to simulate the complex flow of the oil around the e-machine windings. From this it is possible to export the heat transfer coefficients (HTC). This can then be combined with the power loss in the windings to model the temperature at the surface and give indications of poorly cooled areas.

2.3 Motor Design and Cooling Strategy

A high power density e-machine has been developed by DSD for an automotive application using state of the art e-machine design software. Initially a winding temperature prediction was carried out using correlation to empirical data. The data showed a step change in temperature under certain conditions which is due to the discrete nature of the empirical data.

The design, Figure 3, uses a series of spray cooling jets to introduce oil onto the windings, which then drains down into a remote sump (not shown) allowing the oil to settle and de-aerate. An oil to air radiator is used to cool the oil before it reaches the e-machine.

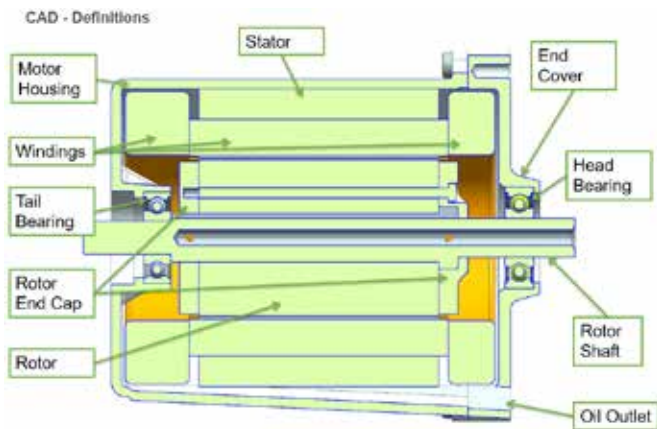

Fig. 3 - e-machine Design

A single oil spray nozzle feeds oil to each end of the windings from the highest point on the casing. A nozzle also feeds oil directly up the centre of the rotor shaft, with four radial drillings spreading this oil to the inside of the windings. The pump selected for this design is capable of supplying 8L/min of oil to the e-machine. An initial estimate of the required flow rate split is shown in Figure 4.

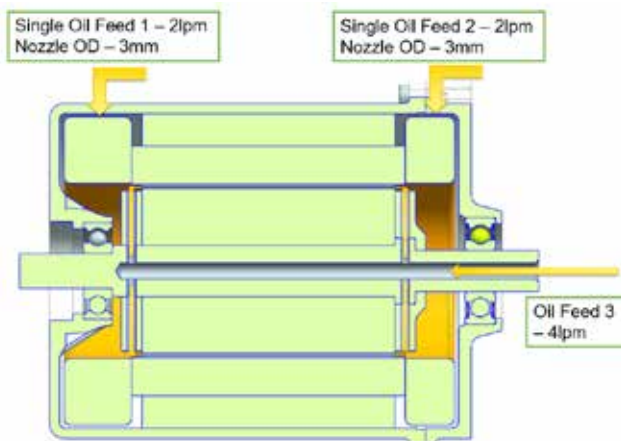

Fig. 4 - Initial Oil Requirements

This e-machine is required to run at the continuous high power and building an analytical model offers the opportunity to test the estimated oil cooling and optimise the cooling regime.

2.4 Modelling the System

It has previously been shown how the flow of oil using an MPS method can be correlated to test data (6). Figure 5 shows the model used in this test.

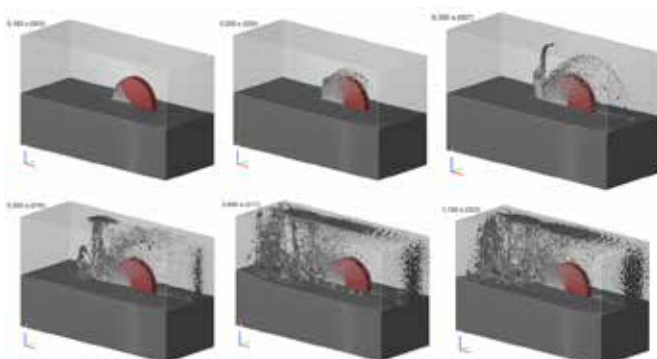

Fig. 5 - Correlation model of single gear in oil (6)

For the e-machine analysis a model was generated in Particleworks, using imported CAD. The solid components were imported as grouped bodies based on how they will behave within the model. The rotor was combined with the bearing inner races and elements into a single body as these will all rotate about the same axis (Figure 6) to reduce pre-processing time.

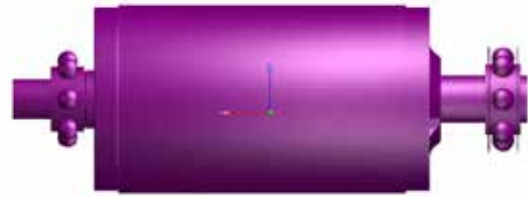

Fig. 6 - Rotating Components

The stator and windings were imported as separate bodies so that information such as heat transfer coefficients could be investigated for these components individually (Figure 7).

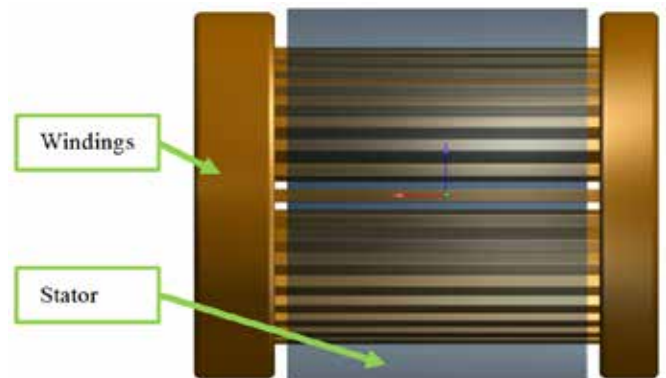

Fig. 7 - Stationary Components

The inner surface of the casing, including the bearing outer races, was extracted to create an oil tight containment volume, with the outer surface simplified to a cube (Figure 8). This simplification was carried out to reduce the pre-processing time required to generate the distance functions for the solid body.

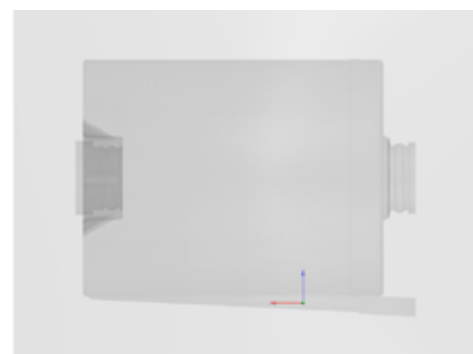

Fig. 8 - Containment Volume

An initial model was generated which isolated the rotor assembly to calculate the oil flow through the radial drillings. The rotor shaft was placed within a cubic domain with an oil feed into the centre of the shaft. The rotor was set to rotate at 3000RPM, with the oil fed at a rate of 4L/min.

Once the flow had become stable, the flow rate from each orifice was measured as shown in Table 1. Figure 9 shows the rotor shaft

| Orifice | Flow Rate (L/min) | Percentage |
|----------|-------------------|------------|
| Inlet | 4 | 100 |
| Outlet 1 | 1.0109 | 25.27 |
| Outlet 2 | 1.0096 | 25.24 |
| Outlet 3 | 0.9896 | 24.74 |
| Outlet 4 | 0.9899 | 24.75 |

Table 1 - Flow Rate at Inlet and Outlets

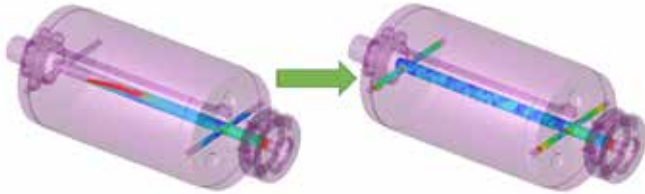

Fig. 9 - Oil Flow Through Rotor Shaft

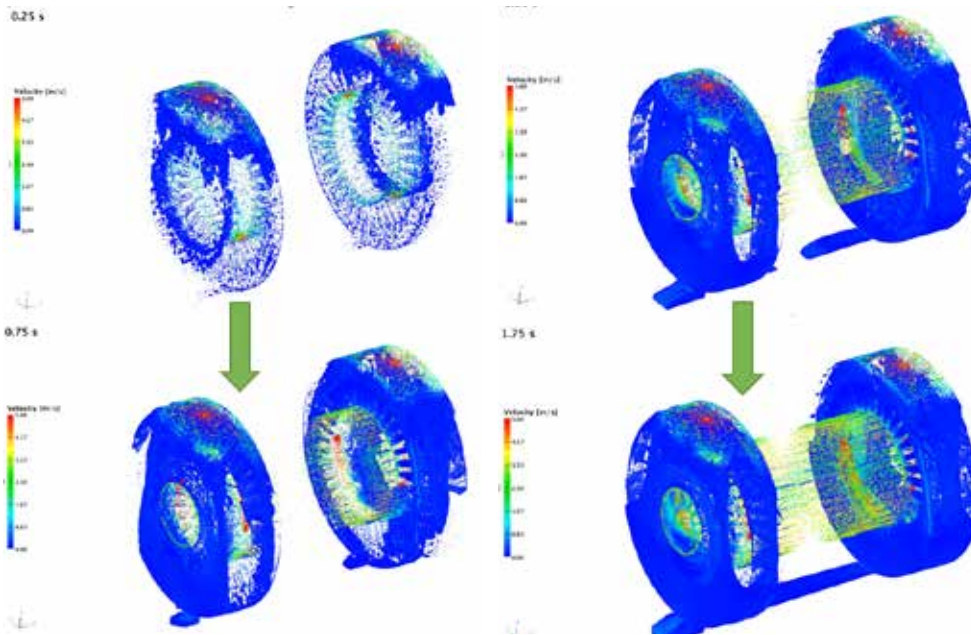

Fig. 10 - Development of Oil Flow (Without Air)

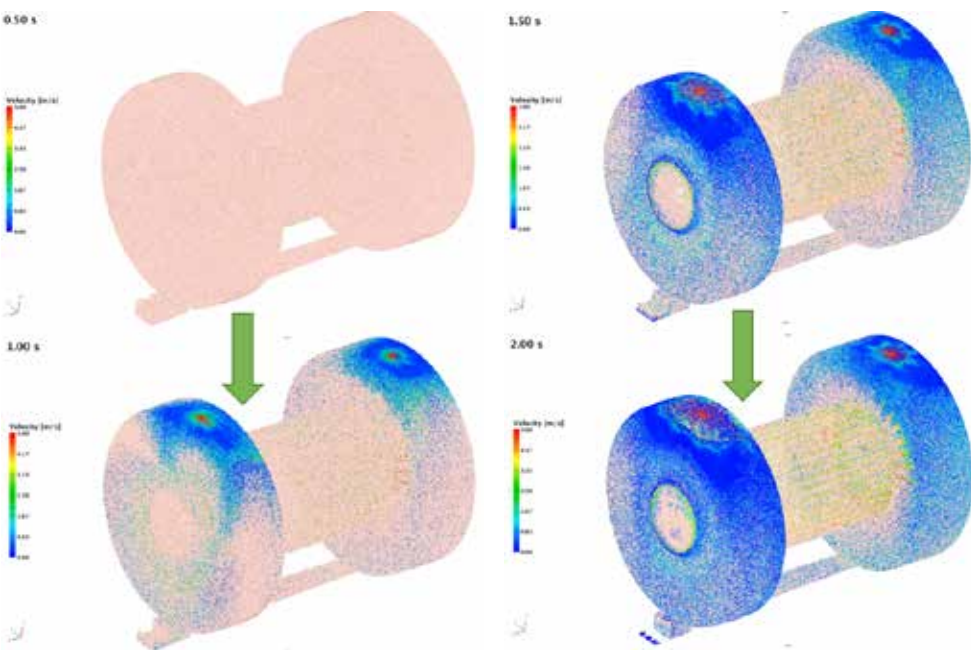

Fig. 11 - Development of Oil Flow (With Air)

before flow had stabilised and after flow had stabilised and the rotor becomes saturated.

As the flow rate of each orifice is approximately equal, a fixed flow rate equal to one quarter of the input flow will be used at each orifice in the complete model to reduce the computation time required to solve.

A complete model was generated, including the modelling simplification described above. For low speed applications it is possible to model an enclosed volume without air to significantly decrease the computation time required. As the tip speed on the rotor shaft is between high speed and low speed, back to back models were generated with and without air to determine whether it was necessary. Figure 10 shows the development of the oil flow

in the model without air, coloured by velocity. The model shows, in the circled region, areas where oil doesn't appear to reach.

Figure 11 shows the oil and air flow developing in the model with air, the air particles are coloured pink throughout whilst the oil is coloured by velocity. From the test described above, it was deemed that the model with air would provide a more accurate model of the fluid movement and hence the HTC. A comparison of the HTC map for the models without and with air is shown in Figure 12 and Figure 13. It can be seen that in the model without air the HTC is very low in the areas where oil isn't reaching in significant quantities.

This is to be expected as the model assumes a vacuum where there isn't oil. The model with air shows a more even distribution of HTC. This aligns with expectation well as the air will be dragged around as the rotor spins, meaning that it will also have a cooling effect on the windings. Although it would reduce computation time further, it was deemed that modelling without air would not produce reliable results. To check whether these results fall within the expected range, a hand calculation was performed using the Dittus-Boelter Correlation at the point of the top inlet. The HTC predicted at this point by hand calculation is within 10% of the HTC predicted by the model.

3.92 s

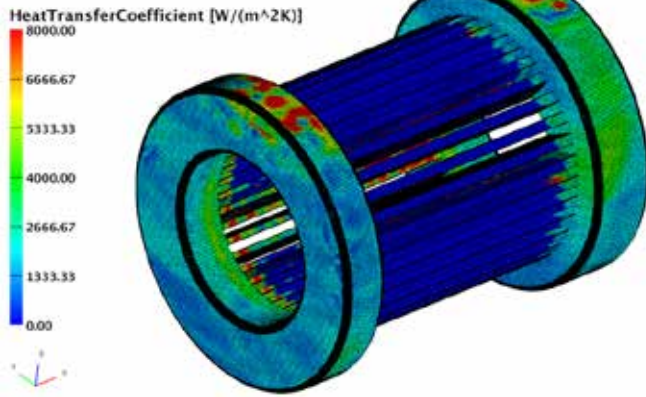

Fig. 12 - HTC Map (Without Air)

3.17 s

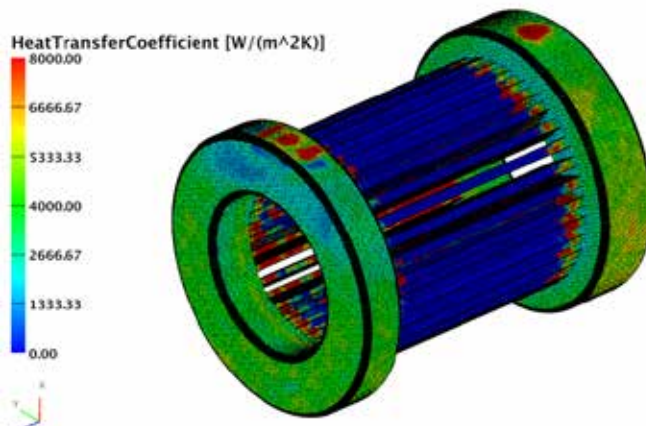

Fig. 13 - HTC Map (With Air)

2.5 Temperature Mapping

The HTC map was exported from the model once the flow field had stabilised. This was then mapped onto a solid mesh in FE software. The power loss predicted in the windings, from the motor design software, was applied to the windings as a volumetric power loss. Whilst the losses vary over very short distances, for the purpose of developing a simplified design tool it was assumed that the power loss is equal across the windings. This simplification will help to minimise set up time for the thermal models.

It is impractical to model each individual wire in the motor windings at a concept level, especially when these are to be analysed using FE. The insulation is very thin and would require a very fine mesh to capture correctly, greatly increasing the number of elements in the model. This would require an impractically large amount of computation time to solve (7) (8).

A method for estimating the bulk properties of a homogenised winding material has been validated by Simpson et al. (7). The effective thermal conductivity, k_e , of the winding material can be estimated using the Hashkin and Shtrickman approximation:

$$k_e = k_p \frac{(1 + v_c)k_c + (1 - v_c)k_p}{(1 - v_c)k_c + (1 + v_c)k_p}$$

Equation 1 - Hashkin & Shtrickman Approximation

Where k denotes thermal conductivity, v denotes volumetric ratio with $v_c + v_p = 1$, and the subscripts e denotes effective, c denotes conductor and p denotes potting compound. The effective specific heat capacity, c_e , of the bulk material can be estimated using:

$$c_e = \frac{PF(\rho_c c_c - \rho_p c_p) + \rho_p c_p}{PF(\rho_c - \rho_p) + \rho_p}$$

Equation 2 - Specific Heat Capacity Estimation

Where c , ρ , and PF denote specific heat capacity, density and packing factor respectively. The subscripts c and p denote conductor and potting compound respectively. By applying these homogenised properties to the winding, the FE model can be significantly simplified with a small reduction in accuracy (7).

A steady state heat transfer problem was then carried out using the FE solver.

3. Results

The results from the steady state heat transfer problem are shown in Figure 14. The results show low temperatures in the expected areas, the areas where the oil inlets are situated are effectively cooled by the direct jets. The inner surface of the end windings also shows a well defined region of lower temperature where the rotor shaft oil feed exits.

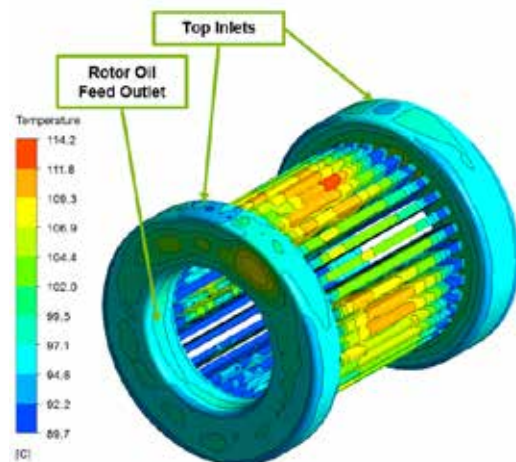

Fig. 14 - Temperature Map (4L/min in Rotor Shaft)

The windings which are situated within the stator show a higher temperature due to the lack of oil in this area (Figure 15). Whilst this

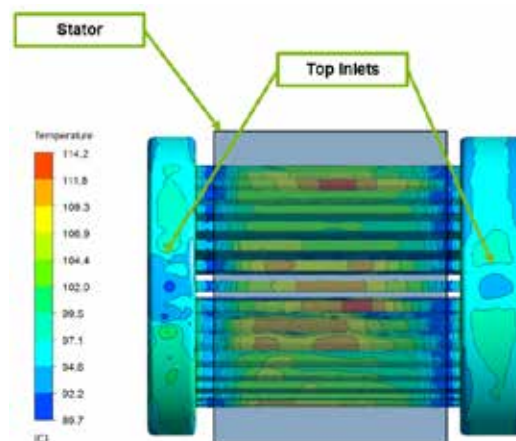

Fig. 15 - Temperature Map (4L/min in Rotor Shaft) Viewed From Above

is expected due to the relatively low convective heat transfer in this area, the temperature may be lower in reality as there would be heat conduction through the stator which has not been accounted for.

The peak temperature is 124.9°C, found in the centre of windings (Figure 16) whilst the average temperature across the entire windings is 103.6°C.

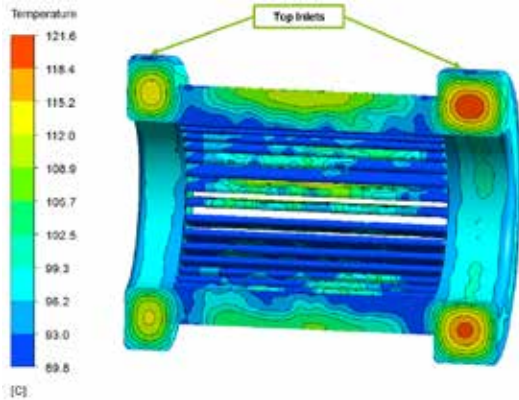

Fig. 16 - Temperature Map (4L/min in Rotor Shaft) Viewed in Section

The model was iterated using different flow rates in each area to test whether further optimisation was possible with the current package and pump restrictions. The additional test points are summarised in Table 2.

| Model Name | Oil in rotor shaft (L/min) | Oil in each top inlet (L/min) | Total oil in (L/min) |
|------------|----------------------------|-------------------------------|----------------------|
| A | 4 | 2 | 8 |
| B | 6 | 1 | 8 |
| C | 2 | 3 | 8 |

Table 1 - Flow Rate at Inlet and Outlets

Model B shows a similar pattern of temperature distribution to model A (Figure 17) but with generally slightly lower temperatures across the end windings.

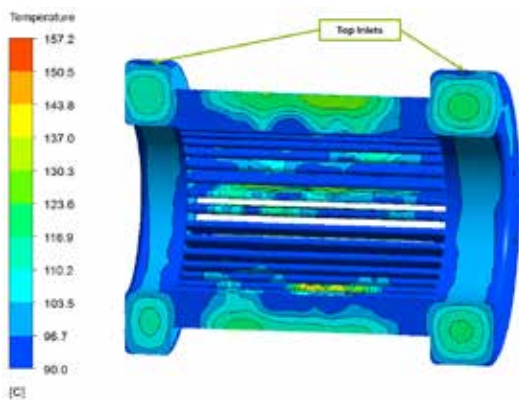

Fig. 17 - Temperature Map (6L/min in Rotor Shaft)

As with model A, high temperatures are seen in the area covered by the stator (Figure 18).

The peak temperature is 145.0°C, found in a very localised area in the section of windings covered by the stator (Figure 19) whilst the average temperature across the entire windings is 105.1°C.

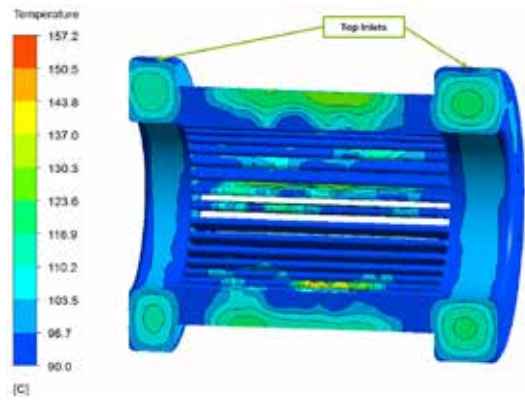

Fig. 19 - Temperature Map (6L/min in Rotor Shaft) Viewed in Section

Model C also shows a similar temperature distribution to models A and B (shown in Figure 20)

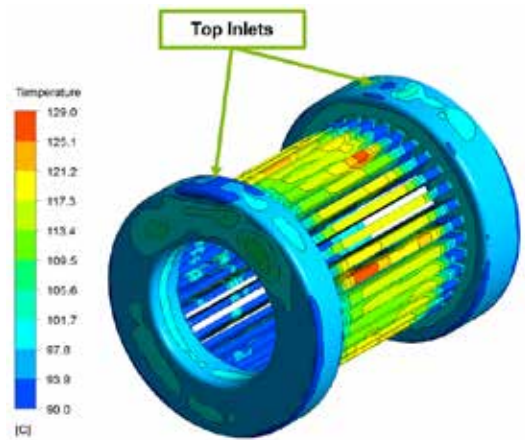

Fig. 20 - Temperature Map (2L/min in Rotor Shaft)

Again, the windings show high temperatures in the area covered by the stator (Figure 21).

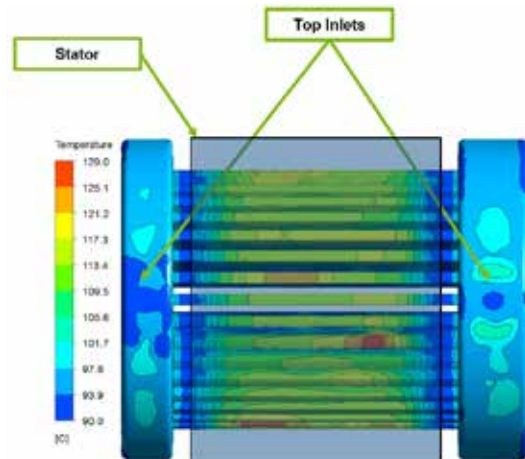

Fig. 21 - Temperature Map (2L/min in Rotor Shaft) Viewed From Above

In section view, it can be seen that in model C the highest temperature is found in the centre of the windings (Figure 22). The peak temperature is 129.0°C, whilst the average temperature across the entire windings is 105.0°C. The temperatures predicted by the standard motor design software for the same conditions as model A are shown in Table 3 along with the temperatures predicted using this novel method.

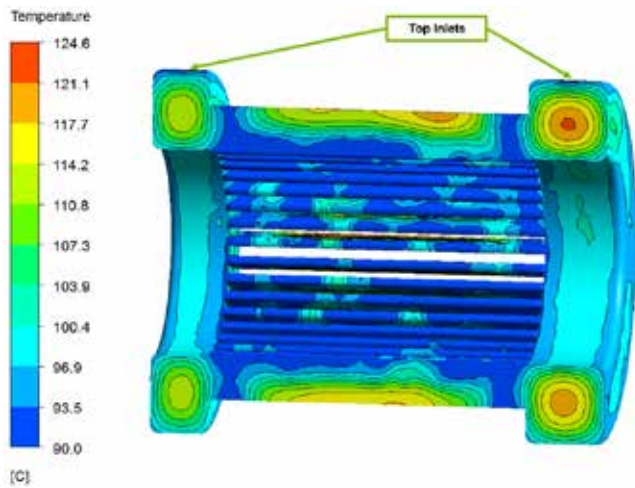

Fig. 22 - Temperature Map (2L/min in Rotor Shaft) Viewed in Section

| Model | Peak Temp (°C) | Avg Temp (°C) |
|------------------------------------------|----------------|---------------|
| A | 124.9 | 103.9 |
| B | 145.0 | 105.1 |
| C | 129.0 | 105.0 |
| Standard Motor Design Software (Model A) | 122.0 | 115.6 |

Table 3 - Summary of Model Results

Model A, the initial estimation of flow requirements, appears to give the lowest peak temperature and lowest average temperature across the windings. This aligns with the expected trend from hand calculations. The peak temperature predicted is very similar to the standard motor design software, <2.5% difference. The average temperature predicted shows a larger difference, ~10%.

Each MPS model was set up in under half a day, with approx. 3 days of solve time on modest computer hardware. A further day was required to postprocess and solve the steady state heat transfer. This means that a set of results can be obtained in under 1 week, much less than traditional finite volume CFD techniques.

4. Conclusions

A new method for solving the heat transfer prediction problem in an e-machine has been shown. The results have been benchmarked against other existing techniques.

A suitable assumption to merge the end windings into an equivalent mass has been carried out for the purpose of this concept study. For detailed motor analysis it is feasible to model the individual end windings, however this is at the expense of computation time. It is deemed that one inaccuracy in the models is the absence of conductivity to the stator. This is currently planned to be included in the model.

As the time taken to set up and solve the model is under 1 week, this technique offers a credible method to predict temperature at the early design stage. This will allow for a more informed comparison of different designs, enabling greater optimisation of e-machine thermal performance.

Machine testing is planned during 2018 to correlate models, and refine the process.

5. Glossary

- APC: Advanced Propulsion Centre
- CFD: Computational Fluid Dynamics
- EV: Electric Vehicles
- FE/FEA: Finite Element (Analysis)
- GPU: Graphical Processing Unit
- HTC: Heat Transfer Coefficient
- ICE: Internal Combustion Engine
- MPS: Moving Particle Semi-Implicit (method)
- OEM: Original Equipment Manufacturer

References

1. International Council On Clean Transportation. EU CO2 Emission Standards For Passenger Cars And Light-Commercial Vehicles. [Online] January 2014. [Cited: 28 March 2018.] https://www.theicct.org/sites/default/files/publications/ICCTupdate_EU-95gram_jan2014.pdf.
2. Low cost, Low drag passive lubrication system developed with smoothed particle hydrodynamics. Hole, Matt. Berlin: CTI Symposium Automotive Transmissions, HEV and EV Drives, 2017.
3. Block, David and Brooker, Paul. 2015 Electric Vehicle Market Summary and Barriers. [Online] 30 July 2016. [Cited: 28 March 2018.] <http://www.fsec.ucf.edu/en/publications/pdf/FSEC-CR-2027-16.pdf>.
4. International Energy Agency. Global EV Outlook 2017. [Online] 2017. [Cited: 28 March 2018.] <https://www.iea.org/publications/freepublications/publication/GlobalEVO Outlook2017.pdf>.
5. Advanced Propulsion Centre UK. APC Electric Machines Roadmap. <http://www.apcuk.co.uk>. [Online] December 2017. [Cited: 03 April 2018.] http://www.apcuk.co.uk/wp-content/uploads/2017/12/EMC_Full_Pack.pdf.
6. Galbiati, Massimo. Oil Splashing, Lubrication and Churning Losses Prediction by Moving Particle Simulation. NAFEMS World Conference 2017. [Online] June 2017. [Cited: 07 April 2018.] https://www.nafems.org/congress/presentation_downloads/.
7. Estimation of Equivalent Thermal Parameters of Electrical Windings. Simpson, N, Mellor, P H and Wrobel, R.
8. Estimation of Equivalent Thermal Conductivity for Impregnated Electrical Windings Formed from Profiled Rectangular Conductors. Ayat, S, et al.

L. Martinelli, M. Hole - Drive System Design Ltd
D. Pesenti, M. Galbiati - EnginSoft

For more information:
www.drivesystemdesign.com



Fig. 2 - Offshore wind turbines

Helping engineers in the Green Technology industry overcome their design challenges



The Green Technology Industry poses many different challenges for engineers. From meeting environmental requirements while producing power, to achieving predictable power output despite the numerous variables and unpredictable changes; from optimizing power generation and reducing development risks in energy management projects, to designing multi-domain systems such as Electric Vehicles and adapting quickly to system changes, each field has unique issues.

- integrate multiple domains in the same system model (mechanics, hydraulics, electrical, controls, etc.);
- create a virtual model of a physical system directly from its CAD representation and easily characterize it;
- optimize system performance through high-fidelity models;
- easily apply advanced analytical tools to help identify solutions to complex problems.

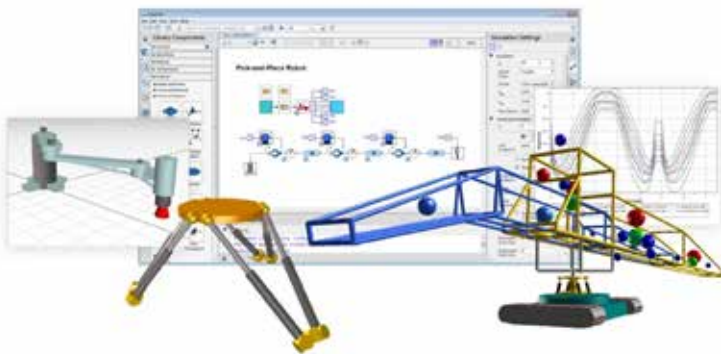

Fig. 1 - Maple and MapleSim allow engineers to successfully address systems design challenges

MapleSim provides an answer to these challenges. It allows engineers to easily create multi-domain systems models and then verify that these models meet their requirements. It enables the engineers to optimize the performance of these models and to seamlessly integrate them with system engineering and multi-objective optimization solutions. In addition, Maple's cutting-edge symbolic calculus solver is able to run complex model simulations extremely fast.

MapleSim allows engineers to:

- quickly develop accurate virtual prototypes to predict system performance at early design stages;

What follows are the highlights of a few MapleSim case studies that involve multi-domain integration and optimization.

Wind turbine and power generation modeling and optimization

Fast becoming a major source of power around the world, wind power generation looks ever more promising in terms of supply stability, environmental suitability, and safety. The Global Wind Energy Council has a strong outlook for wind power and

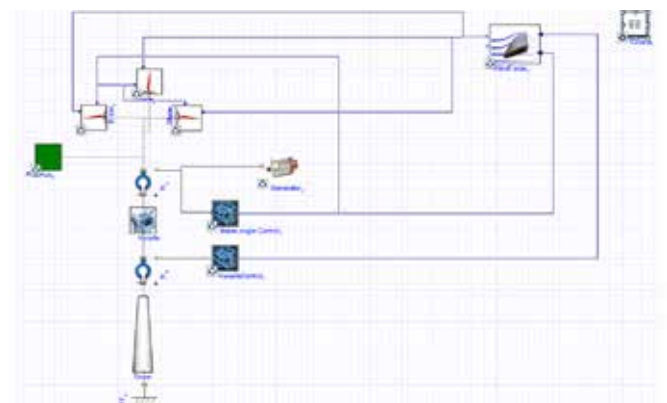

Fig. 3 - Wind turbine model in MapleSim

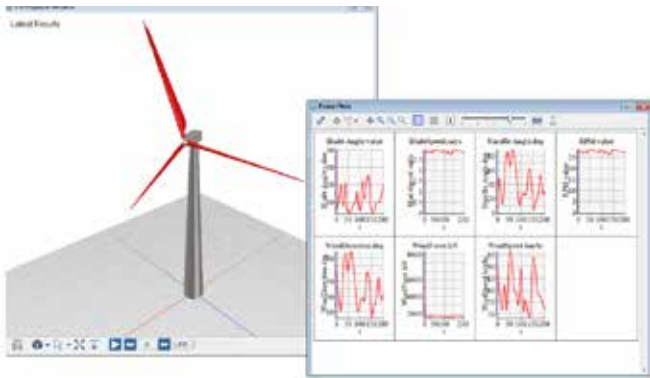

Fig. 4 - Wind turbine 3D model and outputs

predicts a global installed capacity of over 800GW by 2021. Growing demand for reliable, cost-effective and environmentally friendly generation systems along with strict government norms to reduce greenhouse gas emissions are the driving forces behind the wind energy market growth. Wind turbine manufacturers and energy providers are now focusing their research and development efforts to ensure the reliability for installation environments and to offer highly cost-effective wind turbines. This is particularly necessary for off-shore wind farms in coastal waters where the environment is more demanding, and maintenance or repairs are more difficult and costly. This has led to the development of specific turbine models for offshore wind farms.

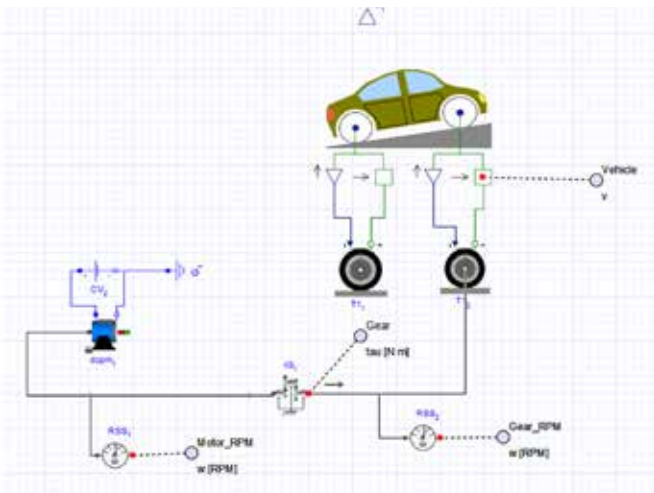

Fig. 5 - A simple Electric Vehicle model

This case study focuses on turbine power generation. The implemented model simulates the power generated as wind passes over the blades. The goal was to stabilize power generation by controlling the nacelle and blade pitch angle. This was done by using a DC motor to align the nacelle in the wind direction, as well as by controlling the angle of attack by rotating the blades to reduce the induced drag. The mechanical power generated is converted to electrical power using a DC permanent magnet motor as a generator.

A more stable energy supply provides benefits wind farm operators which are then able to increase the quality of their power supply quality and decrease their reliability costs.

Electric vehicle system engineering

New-generation electric and hybrid-electric vehicles (HEV) present significant challenges to automotive engineers. The complex multidomain systems involved must be modeled in a single environment, so that design and optimization can be carried out at a system level. MapleSim allows engineers to develop multidisciplinary models to expose the underlying complex interactions between systems, determine component sizing, achieve higher fuel efficiency, and then validate by means of hardware-in-the-loop testing.

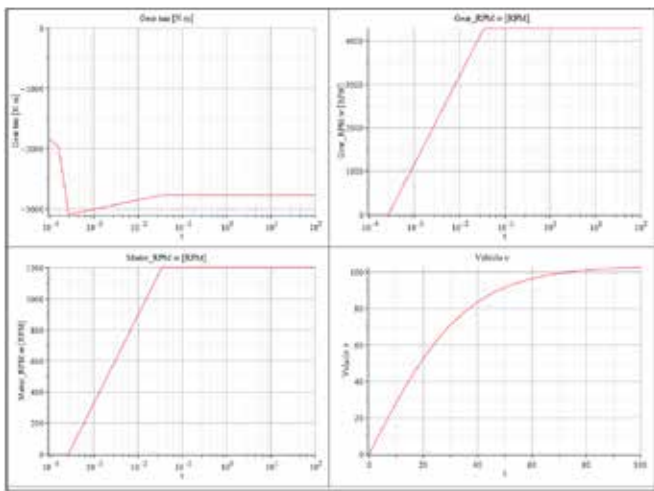

Fig. 6 - EV model outputs

As a first example, a model has been developed of a multi-domain vehicle starting from the simple electric vehicle (EV) specifications (such as vehicle curb mass, aerodynamic drag coefficient, gearbox efficiency, etc.) and the selected motor specifications (i.e. provided as a specific motor $\tau - \omega$ curve) This EV model includes 1-D Mechanical and Driveline MapleSim libraries.

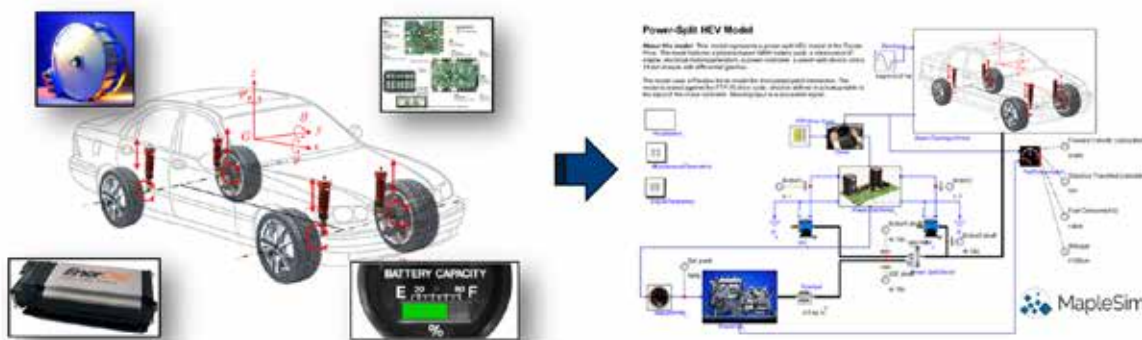

Fig. 7 - An example of a multi-domain HEV system in MapleSim



Fig. 8 - MapleSim Fleet Forward for EV fleet management

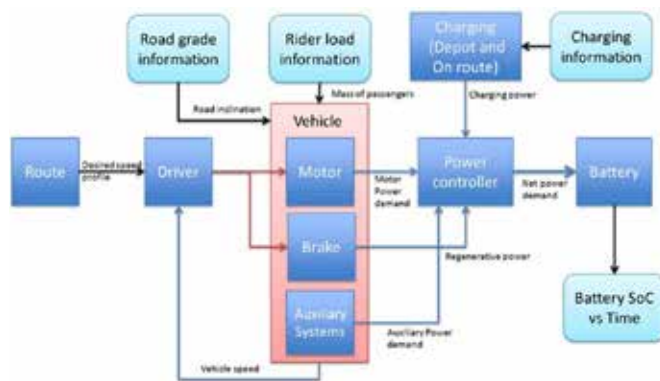

Fig. 9 - Components of a typical electric bus transit environment



Fig. 10 - A small part of NRC's analysis tools is this overlay plotting window

Once this model was parameterized, an analysis could be performed to find out the effect of the gear ratios and calculate whether the motor satisfies the constraints for the maximum slope rate that can be achieved by the EV.

Such simple models can easily be further expanded to describe complex systems and manage multiple design requirements. Furthermore, they can be integrated with Model-Based System Engineering (MBSE) tools which allow for efficient design verification and validation against multiple requirements, throughout the development process.

MapleSim Fleet Forward: a solution for EV fleet management

With concerns for carbon emissions becoming a critical issue, it is increasingly important to transport more commuters using public transit while simultaneously decreasing the environmental impact of these operations. This requires the implementation of new vehicle technologies into existing fleets, which can introduce a host of risks if undertaken without the proper research and analysis.

The National Research Council of Canada (NRC), partnering with Maplesoft, has taken a leadership role in the research of vehicle fleet performance in cities across Canada. With an initial focus on

the electrification of public transit, the NRC and Maplesoft developed a comprehensive, model-based tool to simulate the performance of an electric bus fleet in a given city. The purpose of developing the model was to help transit authorities better understand the operational impacts of integrating this new electrification technology into their current fleets without disrupting ongoing operations.

Together, the NRC and Maplesoft have developed MapleSim Fleet Forward, a tool for model-based decisions in transit electrification. The tool plays a central role in the NRC's Fleet Forward Methodology -- a methodology developed and used by the NRC to reduce the risk of deploying battery-electric buses across Canadian municipalities. By incorporating bus configurations, routing information, and a variety of other design parameters, the NRC is able to determine the suitability of a specific route for electrification. This level of detail enables them to define the requirements for particular bus configurations and charging options, ensuring that the investigating transit authority is well prepared for any operational challenges. MapleSim Fleet Forward has established itself as a tool that will help inform operators, equipment manufacturers and regulators, while at the same time improve public transit as a whole.

Conclusion

MapleSim provides a user-friendly environment for the design and simulation of multi-domain systems. Thanks to these features and its comprehensive component libraries, MapleSim lets green technology engineers accelerate their product development by customizing software models for batteries, full electric and hybrid electric vehicles, renewable energy generation, etc. MapleSim models are optimized for speed and accuracy and therefore can be seamlessly integrated with System Engineering and Multi-Objective Optimization solutions for design verification and increased performance.

For more information, contact:
Giovanni Borzi - EnginSoft
g.borzi@enginsoft.com

Maplesoft is Sponsor of the
International CAE Conference 2018

www.caeconference.com



Fig. 1 - Razor Scooter being tested



Fig. 2 - DTS Slice Micro DAQ



Strains and Load reconstruction of two-wheeled Scooters

Cost-effective, efficient method of calculating complex loading on structures

The following article provides a complete evaluation of a 2-wheeled Razor™ Scooter with analysis models and experimental strain measurement. It shows the application of the commercial software True-Load to calculate operating loads from a variety of dynamic loading events. This software leverages the concept of influence coefficients for the purpose of load reconstruction. It includes correlation plots of simulated strain versus measured strain; the simulated strains are derived from the loads calculated from the load reconstruction of the measured strains. The Razor Scooter is an inexpensive children's scooter. The evaluation simulated the X, Y, Z loads at the foot, and X, Y, Z loads and RY moments at the rear wheel. The loading events ranged from static to extreme riding over sidewalk and roadway surfaces.

Problem description

This simulation exercise recovered the loading on the Razor Scooter, purchased from Amazon. The 3D model of the scooter was reverse engineered. A large portion of the instrumentation work was performed by Wolf Star Technologies' intern, DeAngelo Stewart. The data acquisition (DAQ) system used was a 12-channel DTS Slice Micro DAQ. The unit is powered by a small battery. Data is downloaded via USB cable. The strain gauges used were Micro Measurements CEA-XX-250UW-350-P2 strain gauges, which are 0.250-inch gauge length gauges with pre-soldered lead wires. The lead wires were trimmed short and attached to the shielded cabling of the DAQ system to minimize external electronic noise.

Unit Loads

The unit loads for the Razor Scooter were created in a Finite Element Analysis (FEA) model. The unit loads were applied

at the foot contact point (FX, FY, FZ), the rear tire patch (FY, FZ, MY), and the center of the rear axle (FX). The bottom of the steering stem was fixed in three-degrees-of-freedom (3DOF). The top of the steering stem was fixed in two-degrees-of-freedom (2DOF). The 2DOF at the top are the radial DOF.

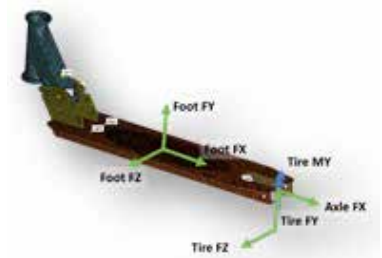

Fig. 4 - FEA Unit Loads

A coordinate system was created along the axis of the steering stem for the restraints. This coordinate system was also used for the inertial relief. The inertia relief used only the rotation DOF going through the center of the steering stem. The FEA solution Inertia Relief (IRL) was used to eliminate the singularities introduced by insufficient restraints.



Fig. 5 - Virtual Strain Gauge Placement

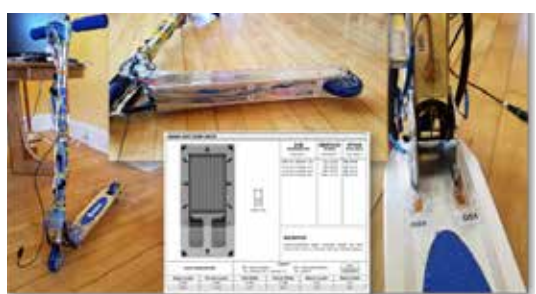

Fig. 3 - Strain Gauge Placement

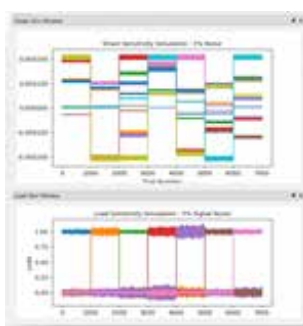

Fig. 6 - Load Sensitivity to Strain Signal Noise

Pre-Test

The True-Load/Pre-Test software was used to leverage the seven, unit load cases and the corresponding strain results from the FEA model. The final strain gauge placement is shown in Figure 5. An important phenomena to understand is the stability of the correlation matrix. The True-Load software provides a utility that calculates the ideal strain for each unit load case and then applies a 5% random signal noise to the idealized strain. These strain signals are then multiplied by the correlation matrix to determine

the corresponding load response. Ideally, each load should be turned on one-by-one and the other loads would be turned off. The plot in Figure 6 shows the load sensitivity to strain noise for this configuration of gauges. This plot shows that the system of gauges chosen produced a very stable system of load reconstruction that could tolerate noise in the strain signals.

Strain Gauge Application

A series of drawings was created to locate the strain gauges on the physical structure. These drawings were then used to place the gauges on the physical part using calipers and other measurement techniques.



Fig. 7 - Strain Gauge Installation

Test-Data Collection

Once the scooter had been fully instrumented, the strain gauges were connected to the DTS Slice Micro DAQ system. The strain data was sampled at 1000 samples per second. The data collection was performed under normal operation on a variety of surfaces. A typical trace of strain data is shown below.



Fig. 8 - DAQ used for Strain Data Collection

Post-Test

Once the strain data had been collected, it was processed to reconstruct the loading applied to the system. This was done by multiplying the measured strain data by the correlation matrix extracted from the FEA model (Figure 9). The result was a time history of the loading scale factors for each of the loads applied to the scooter (Figure 10).

The True-Load/Post-Test software was used to perform this load reconstruction. In addition to the load reconstruction, several automatic post-processing tasks were performed. This produced an HTML report that contained plots of the reconstructed loads and a set of plots showing the measured strain and the simulated strain from the reconstructed loads at the strain gauge locations in the FEA model. These measured/simulated strain plots were summarized in an overall plot of the simulated strain (blue) and the measured strain (green). A cross plot of the simulated vs the measured strain was produced by the Post-Test software. Ideally this should be (and was) a perfectly straight line along a 45-degree angle (Figure 11).

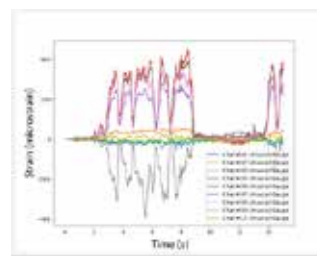

Fig. 9 - Typical Strain Traces from Test

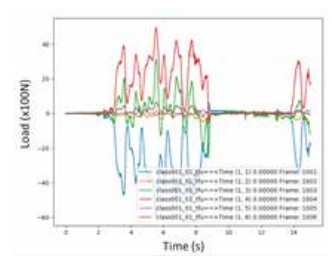

Fig. 10 - Reconstructed Loads

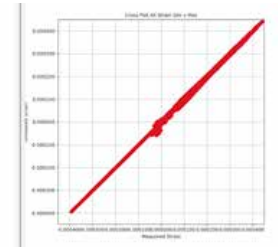
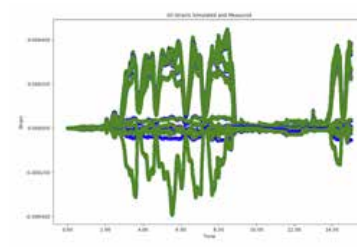

Fig. 11 - Overall Strain Correlation Plot

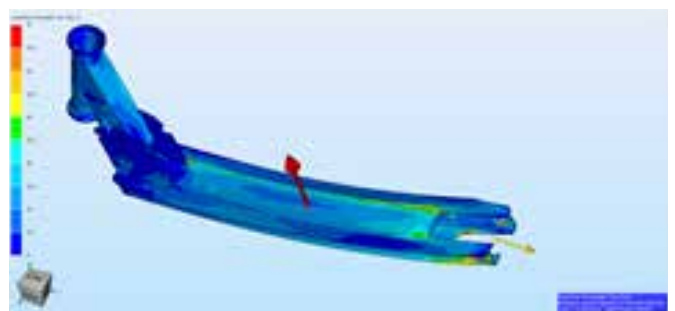

Fig. 12 - Typical Frame from a Reconstructed Operating Deflection Shape

Post-Processing

Once confidence in the reconstructed loads was acquired, the detailed post-processing of the FEA model could be performed. Having a complete time history of the loads, it was possible to construct the operating deflection shapes of the entire scooter utilizing the time history of loading and the FEA model. Figure 12 shows a typical frame plot from an operating deflection shape on the scooter.

Conclusion

This article has shown that complex, nonlinear loading on a structure can be recovered with very high accuracy. The loading DOF were sufficiently complex (FX, FY, FZ at the foot, FX at axle, FY, FZ, MY at the tire patch) to make this a non-trivial problem. If traditional load measurement techniques had been deployed, the scooter would have been rendered inoperable. A 3DOF load transducer could perhaps be reasonably applied at the foot location. However, extracting the 4 loading DOF on the rear wheel would have required removing the wheel and replacing it with other load transducers, thus rendering the device inoperable. With moderate skill and test plan processes, strain gauges can be efficiently placed on the structure to back-calculate virtually any load that can be conceived by the FEA analyst. The cost to calculate these loads consists of two uniaxial strain gauges per loading DOF, which is approximately \$20. Consequently, this is a highly cost-effective and efficient process for determining complex loading on structures.

Tim Hunter, Ph.D., P.E. - President, Wolf Star Technologies, LLC

For more details on the True-Load software:
Danilo Col - EnginSoft • d.col@enginsoft.com

3D-Simulation Enhances Product Development for Positive Displacement Machines

Introduction

Positive displacement (PD) machines, as shown in Fig. 1, are essential devices in many industrial plants and processes: rotary-screw compressors, either oil-free or oil-injected, are used as gas compressors and superchargers. Scroll compressors are used for heat pumps and air conditioning systems. Moreover, both can also be used as expanders. Rotary vane pumps are used in low-pressure gas applications and even as vacuum pumps. Lobe pumps and eccentric screw pumps are used in the paper, chemical, food, waste-water, and pharmaceutical industries since they can handle liquids, solids, and slurries. Gear pumps, designed as internal gear pumps, external gear pumps, or gerotor pumps, are common for hydraulic power applications or to pump high-viscosity fluids.

3D Computational Fluid Dynamics

Computational Fluid Dynamics (CFD) simulations have the potential to become a key technology in the development process of positive displacement machines. CFD can deliver deep insights into the flow and thermodynamic behavior of PD machines. Although CFD is broadly accepted in academia as well as in industry, it is currently not used as much for PD machines as for other related applications such as axial-flow pumps, centrifugal pumps, or axial compressors. This is because the main challenge in simulating PD machines lies in the fact that the fluid region is subdivided into chambers that transport the fluid. These chambers change in position and shape due to the motion of the rotors. The transport of fluids in the chambers between the rotors, and between the rotors and the casing, requires complex meshes that change within a single computation. Additionally, the reliable identification of losses due to leakage flows, the heat transfer to the rotors, and multiphase effects like cavitation in pumps, or oil injection in compressors, need high spatial-resolution and the meshes need high numerical quality. Therefore, the crucial tasks for robust and reliable CFD simulations of PD machines are to accurately generate the grid to guarantee correct representation of the chamber volumes, and to create sufficient mesh resolution especially within the gaps and in their vicinity.

Meshing Techniques for CFD of PD machines

There are a few approaches that have been investigated over the past few years. They involve automated and hand-made generation of unstructured and structured grids. The most common approach is probably the use



Fig. 1 - Different PD machine types (from left to right): lobe pump, screw compressor, internal gear pump, roots blower. Photos: www.twinmesh.com

Summary of the disadvantages of using the “common” approaches:

- Overlapping meshes: fast but insufficient wall treatment / gap resolution, large models, issues with compressible fluids / limited multiphase.
- Deform-and-remesh method: automatic mesh generation but produces large models, interpolation errors, and stability issues.
- Customized grid generation: best mesh and numerical quality but inefficient due to time-consuming manual mesh generation.

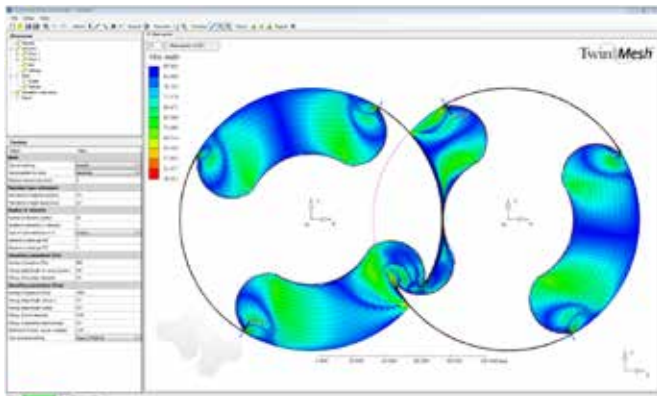

Fig. 2 - TwinMesh GUI showing the mesh quality (min. angle) of a rotary piston pump.

of overlapping meshes (immersed solid method and overset meshes). Other approaches are the deform-and-remesh method and customized grid generation. All these methods have more disadvantages than advantages, as has been summarized in the box to the right.

A Novel Meshing Approach

Consequently, CFX Berlin Software GmbH developed a meshing software (see Fig. 2) to automatically pre-generate high-quality hexahedral grids in a reasonably short time before running a simulation. Hexahedral grids allow the use of all the features and physical models offered by common general-purpose CFD solvers. Hexahedral meshes also permit the best compromise in terms of sufficient spatial-mesh resolution compared to the total number of nodes and elements. Furthermore, the use of block-structured hexa meshes allows engineers to share the same mesh topology for every computational time-step and, therefore, to avoid interpolation between meshes during a simulation. As a result, efficient CFD models with reasonable calculation times can now be generated for rotary PD machines and so CFD simulation can now be utilized on a day-to-day basis in industrial applications.

The overall workflow of the model setup is fairly automated. Grid generation starts with the import of the rotor’s profile curves from the existing CAD geometry and ends with a ready-to-start simulation setup when exporting the 3D grids for all computational time-steps. The software allows the user to define the resolution of the boundary layer near walls, and the resolution of the hex grids of the working chambers and the clearances, with local

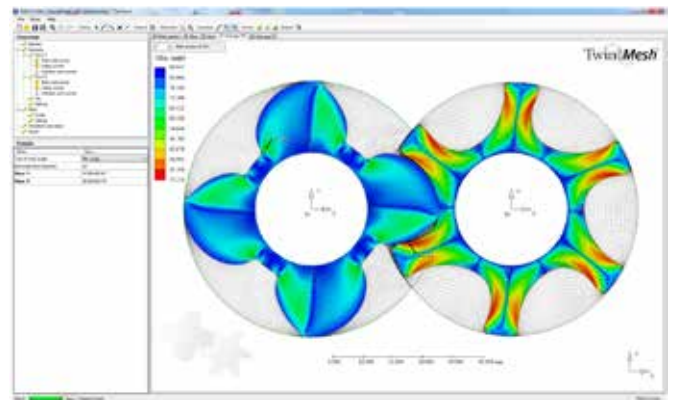

Fig. 3 - Axial gap mesh quality (min angle) of a screw compressor.

refinements. The quality of the elements, e.g. smallest element angle (min angle), aspect ratio of the edges, or volume ratio between connected elements can be visualized and checked, as shown in Fig. 3, before the simulation is started, which ensures both good convergence behavior of the CFD simulation and high-quality results. During run-time, the CFD solver reads the particular grid at the beginning of a time-step. Since all grids have the same topology no interpolation is necessary, and the grid deformation has already been taken into account in the discretization of the fluid system’s partial differential equations. Radial and axial gaps are fully resolved so that leakage flows can also be simulated in full detail.

SE-51.2 Twin Screw Expander Example

To provide a real-world example, a brief discussion of Dortmund University’s simulation of the screw expander SE-51.2 will be presented.

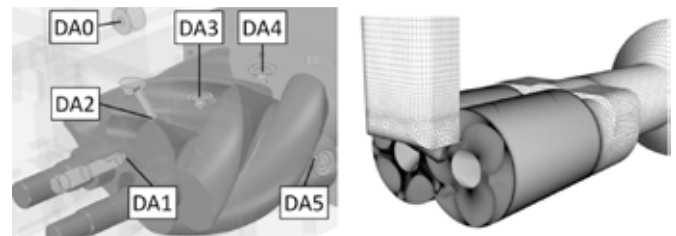

Fig. 4 - CAD model of the SE-51.2 screw expander with pressure measurement points (left) and assembly of rotary and stationary mesh regions (right).

The expander was simulated for several rotational speeds between 1,000 and 16,000 rpm to achieve a pressure ratio of 4:1 with an air-inflow temperature of 90°C. Some variations of the numerical model were performed to achieve the reference operating point of 4,000 rpm. To account for geometric variations, one simulation with a 25% increase in radial clearances (housing gap, intermesh clearance and blow hole) and one simulation with a 25% increase in axial clearances (front gaps) were carried out. A simulation with a decreased mesh-resolution was also performed, decreasing the total number of elements from about 920,000 to approximately 52,000 per rotor chamber. Rotor meshes were coarsened in the radial, axial, and circumferential areas, whereas the stator grids were only coarsened in the interface regions. The simulation

results were compared to experimental data gathered from various pressure sensors, as shown in Fig. 4.

Leakage modelling requires high-quality meshes at high resolutions because coarse meshes tend to result in decreased accuracy in geometric approximation, particularly for the intermesh clearances of rotary PD machines. A comparison of the SE-51.2 twin screw expander's CFD simulation results with the experimental data indicated that the expander's working mechanism and its flow conditions were well captured by the simulation. The smaller pressure-drop measured in the experiment at DA4 was caused by the rotor bearing and represented an additional rotor chamber inflow, which was not modelled in the simulation. Apart from that, the examined flow quantities were in good agreement with the measurements overall, as can be seen in Fig. 5.

The over-estimation of the mass flow (see Fig. 6) that was derived from the coarsened rotor meshes could have mainly been caused by an insufficient spatial resolution of the clearances. In order to account for effects like throttling, chamber refilling, or leakage flows, the computation, therefore, has to have a certain mesh quality. Once this is ensured, CFD easily allows tendencies like the variation of clearances to be analyzed, or the operation point to be changed.

Summary

Internationally-renowned manufacturers such as Gardner Denver, BOSCH, DESMI, Sullair, Danfoss, Nidec GPM, Eaton, Scherzinger, Hanbell, Fusheng, Vogelsang, Börger and others have already adopted CFD simulations for their product development.

Combining the right meshing approach with a reliable CFD solver offers engineers a unique, efficient, and fast workflow for transient, three-dimensional computational fluid and thermal analyses of PD machines with maximum reliability. By using the automated hexa-grid generation method in CFD for PD machines, any engineer can:

- Analyze the flow behavior inside the working chambers of: rotary screw compressors and expanders, internal and external gear pumps, gerotor pumps and orbital motors, lobe pumps and roots blowers, rotary piston pumps, scroll compressors and expanders, conical rotor pumps, progressive cavity pumps, vane pumps, and Wankel engines;
- Analyze complex phenomena such as compressible flow behavior, cavitation, viscous heating, acoustics, and pulsation behavior
- Predict machine performance (mass flow, efficiency, pressure ratio, torques etc.) with no need for physical prototyping

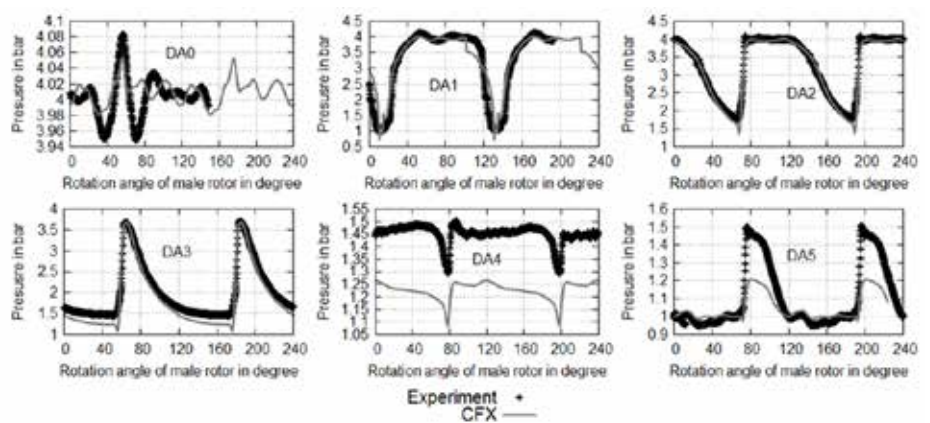

Fig. 5 - Measured and calculated pressure at measuring points DA0 to DA5 at 4,000 rpm.

By offering a unique and efficient workflow and eliminating traditional numerical limits, the automated hexa-grid generation method drives real innovation in the field of PD machines, helping engineers to realize a faster time-to-market, achieve higher machine quality, and decrease development costs. Fluid dynamic and thermal analysis for PD machines has never been more intuitive and accurate.

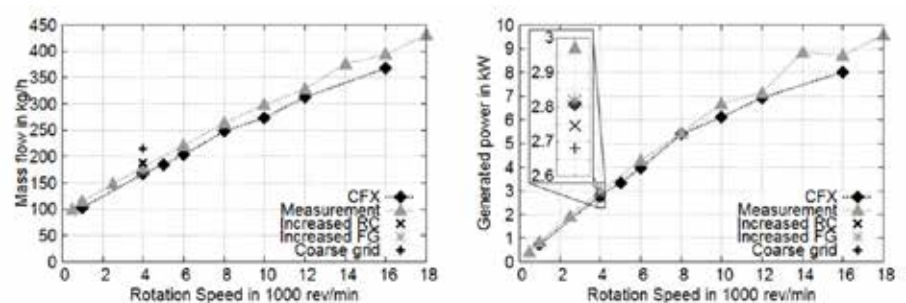

Fig. 6 - Comparison between CFD and measurements: Mass flow (left) and generated power (right) for different operation points with increased radial clearance (RC) and front gaps (FG) grids.

Further Reading and Information

Andres, R., Nikolov, A., Bruemmer, A.: CFD Simulation of a Twin Screw Expander Including Leakage Flows. In 23rd International Compressor Engineering Conference at Purdue, July 11-14, 2016.

Spille-Kohoff, A.; Hesse, J.; El Shorbagy, A.: CFD simulation of a screw compressor including leakage flows and rotor heating. In IOP Conference Series: Materials Science and Engineering (Vol. 90, No. 1, p. 012009).

www.cfd-online.com/Wiki/TwinMesh. www.twinmesh.com

Willie, J., Sachs, R.: Structural and torsional vibration analysis of a dry screw compressor. IOP Conference Series: IOP Conference Series: Materials Science and Engineering (Vol. 90, No. 1, p. 012005).

CFX Berlin is Sponsor of the International CAE Conference 2018

www.caeconference.com

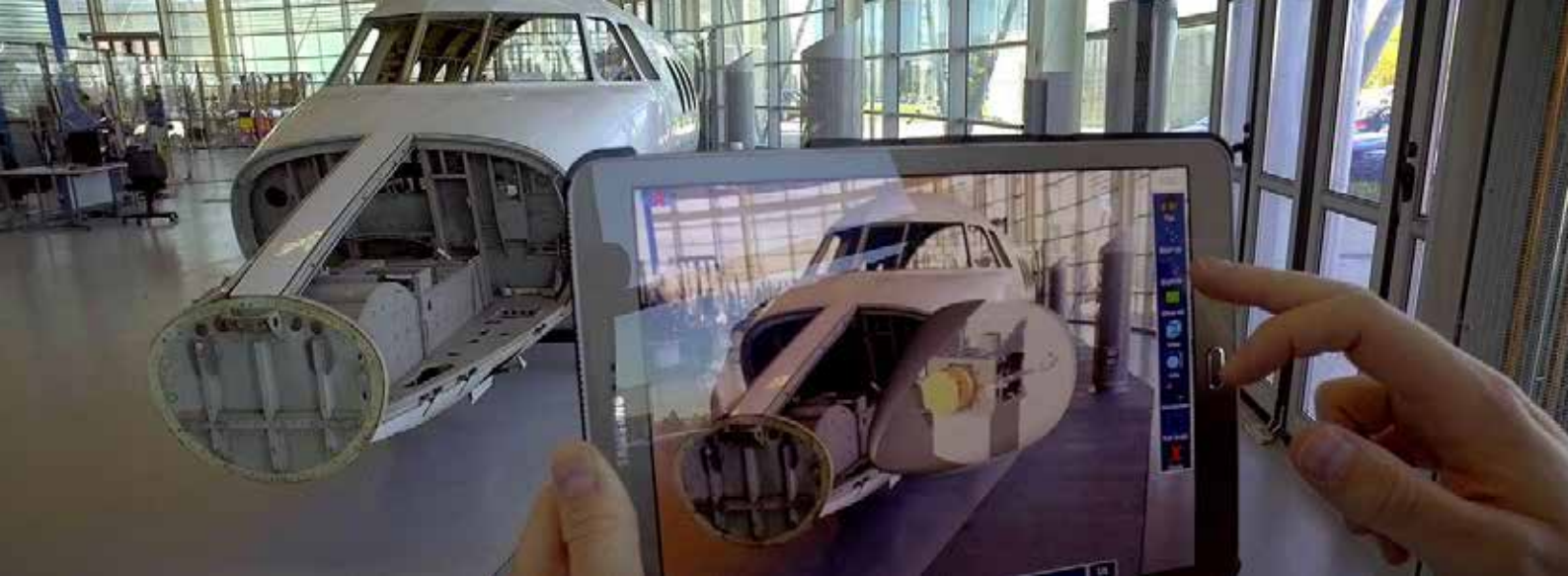

Augmented, Mixed and Virtual Reality in Engineering – Disruptive or Innovative?



There's no escaping the current buzz around augmented, mixed and virtual reality -- over the last 12 to 18 months, the number of new devices and apps being released has risen significantly with most of the big tech companies, such as Apple, Google, Microsoft, Sony, Samsung, HTC, Facebook and HP (among others), trying to get their piece of the action by releasing products onto the market.

It is the gaming and social media worlds, not the engineering and manufacturing worlds, that have driven the development of these new technologies. The latest headsets and apps have been designed with gaming and recreational use in mind, but that's not to say that that is their sole purpose.

As with most 'disruptive' technologies, people are exploring and developing new ways of applying them to different areas. These technologies, and new applications, are merging the gaming and engineering worlds, and the use of these new devices is beginning to cross over and establish itself in the commercial world.

Although engineering and manufacturing processes can be quite entrenched within an organisation -- if it isn't broken, don't fix it -- in the current climate of constant technological advancement and

economic uncertainty, organisations may need to find new ways of getting the job done quicker, but cheaper.

The recent trends towards the digitising of manufacturing with the Internet of Things (IoT), the Industrial Internet of Things (IIoT), Industry 4.0 and Smart Factories means that while integrating more modern, innovative technology into existing workflows could be expensive and disruptive to begin with, in the long run it could save manufacturers money by anticipating future modernisation requirements, and reducing lead times by creating more efficient processes.

The use of augmented, mixed or virtual reality in engineering or manufacturing is still very much in its infancy. There are some large automotive, aerospace and defense companies that have been using virtual reality in caves or powerwalls for many years, but most organisations are just starting to figure out if, and why, they need these new devices and how they can potentially harness the technology.

Now is the time to think about what to do with this technology and how it could work for you -- before you decide upon a device or even begin to determine what ROI you think you can expect.



The first step is all about defining the most appropriate use cases around existing business processes -- and not trying to create problems to solve. It is also important to not fully buy into the media-hype that surrounds the technology trends; you need to ensure that your use cases are appropriate for today's technologies. This will help align your business with the correct device and the correct technology.

Use cases

Augmented (AR), mixed (MR) and virtual reality (VR) technologies can be applied to a wide range of use cases



simulation of the factory floor, the parts needed and the works instructions, so that operators can be trained in how to carry out their tasks -- without making any costly mistakes and without having to occupy expensive equipment for training purposes.

By overlaying the digital geometry and build instructions on top of the physical product in the operator's real-life factory floor environment, the AR and MR technologies enable operators to walk through the build stages. This can be done through a tablet/smartphone (AR) or through a Head Mounted Display (HMD), such as the Microsoft HoloLens (MR).

in the wider enterprise, as well as in engineering and manufacturing, so it's about finding the ones that are right for your organisation and that can add value to the business -- whether that's by saving time, money, or by making existing processes more efficient.

From an engineering and manufacturing perspective, AR, MR and VR can all be integrated into existing workflows, such as manufacturing build and design review processes.

Manufacturing Build

The process of assembling a complex product with many components, such as a car, can be complicated and made up of numerous stages, occupying a large proportion of the workforce. Assembly instructions need to be simple, clear and succinct so that those involved can carry out their specific tasks without any ambiguity or confusion about what they should be doing.

Currently, these instructions are often authored in Manufacturing Execution Systems (MES) software. The advantage of an MES is that it includes any additional information not provided by the CAD designs, such as any supplementary tools that may be required to complete the job.

The instructions are then delivered to the factory floor via a desktop PC, laptop or even on paper. The operators may be required to leave their workstations, check their next task and then return to their workstations to carry out that task. This process clearly causes unnecessary time delays that add up over a production cycle.

For this particular use case, both Augmented and Mixed Reality can be used. At a basic level, Augmented and Mixed Reality in a manufacturing build context essentially represents a different medium for displaying the instructions. Since Virtual Reality is completely immersive and doesn't allow the user to see any of the outside world, it is unfit for this use case because it would be almost impossible for the operator to carry out their assembly tasks. VR can be used, however, in a training context by creating a

Using an HMD has the additional benefit of allowing the operatives to be completely hands-free and, with a headset like the HoloLens, there is the ability to record what is taking place and track what is actually done, for future reference. This can be important: if any assembly-related problems arise in the future, there will be evidence of any possible negligence.

Being able to record videos of the operators carrying out their tasks, and creating a checklist as part of the works instructions, enables organisations to create an audit trail which allows both the operators and management to track the processes and capture progress.

Design Review

Design reviews are an integral part of the product design process, whether as part of the development process for a new idea, or for trialling changes to an existing product. Reviews take place at different points along the product development lifecycle and designs can be reviewed in many different forms -- in 2D on paper or screens, or as 3D life-size or to-scale models. Regardless of the form that the design review takes, it is imperative that every detail of the design can be clearly seen.

Any of the augmented, mixed or virtual reality technologies can be used to carry out a design review, since each provides a different experience in the way that CAD design data can be reviewed.



Using AR or MR to conduct a design review begins with either a completely digital representation or that of a “digital twin” use case. If a design team has an asset, like a 3D model of a product, they can use AR and MR to overlay the digital version onto a physical clay, wood, foam, or even a 3D-printed model. They are then empowered to review the data as a group and can make design decisions collaboratively and efficiently, because they can see the digital model overlaid on top of a physical model or environment.

Accuracy is always important when overlaying digital 3D models onto their intended physical environment. The digitally-overlaid model must line up at an exact 1:1 ratio. The accuracy of the digital twin’s placement on the physical object depends on the quality of the camera in the devices being used to track and map the physical environment and align the digital model.

The Microsoft HoloLens (MR) offers a ‘multi user’ functionality which makes it possible to have groups of people in different locations review



a design, for a completely digital design review experience. Each person involved in the review is represented within the ‘digital room’ by an avatar and has their own individual viewpoint and perspective of the object, but their view is of the digital object in their own physical space. The lead user with control can manipulate and interrogate the object for the others to see, and also pass on control, if necessary.

When modifying existing products i.e. a configuration change, if you have the existing physical product e.g. a vehicle in front of you, designers and engineers can overlay the digital changes, such as to the lights, and see these changes overlaid on the physical car. This makes it much easier to discuss design changes in context.

By putting on a headset and viewing your 3D CAD design model as a hologram, or in a Virtual Reality environment, you get a different perspective, and more interaction with the model. With AR or MR, you’re seeing your design in the real world, or in the case of VR, a digital world, and it allows you to refine your design a lot faster. There aren’t many organisations with well-defined business cases at the moment that can quantify the return on investment, or that have deployed these technologies in a production environment. There are, however, ‘Early Adopters’ who are starting the process with proofs of concept.

Proofs of Concept

Proofs of concept are the only real way to start this journey. Companies are considering augmented, mixed and virtual reality, and exploring which use cases are best suited to the technologies, where the technologies can be used, and how to achieve a financial return.

Even if a suitable use case has been identified, extensive internal support for the use of the devices is necessary -- staff need to be open to trying them and using them, and to thinking about how they can be used. In engineering and manufacturing, while it can be difficult, it is critical to get people’s buy-in, since many existing processes are so well-established that even the slightest change to the status quo could cause resistance.

In the early stages, it is best to remain open-minded, be realistic about what you want to achieve and, from a technology standpoint, to be device-agnostic. Today, nobody really knows which devices are best, or which will win out over time. New devices are appearing all the time and in 12 months’ time, the next generation of the devices will have hit the market. If you’ve tied yourself to one brand or type of device, then your investment could be wasted.

About Theorem

Founded in 1991, Theorem’s products and solutions enable engineering and manufacturing companies to leverage their CAD and PLM assets in other parts of their business, primarily via data sharing with downstream processes and suppliers.

Over the years, Theorem’s range of products has grown as technologies and design needs have evolved. Whilst Theorem still has great success with its original CAD-to-CAD translators, they now also provide CAD-to-Visualization, Process Automation and 3D PDF Publishing solutions.

Theorem’s latest product offering is the ‘Digital Realities’ suite of products that enables engineering and manufacturing organisations, along with their supply chains, to leverage their CAD and PLM data assets and utilise them in Augmented, Mixed and Virtual Reality applications.

Digital Realities is a new paradigm for Theorem Solutions. With Theorem’s history of working with Virtual Reality in Caves and Powerwalls, and because Theorem has been preparing data-to other types of visualisation data for many years, it has extensive knowledge of how to prepare and automate data for these new environments. So taking rich CAD data and making it available in low-cost visualization devices was a natural progression, moving Theorem forward with the technology.

Theorem’s solutions enable companies to reduce engineering and manufacturing costs, improve product quality and functionality, and support the faster development of products and manufacturing processes. Improved data sharing and supplier collaboration while taking advantage of the new visualization technologies, aids companies in getting to market faster, thereby improving their competitive position and achieving a faster return on investment.

For more information visit www.theorem.com
Or contact us at sales@theorem.com

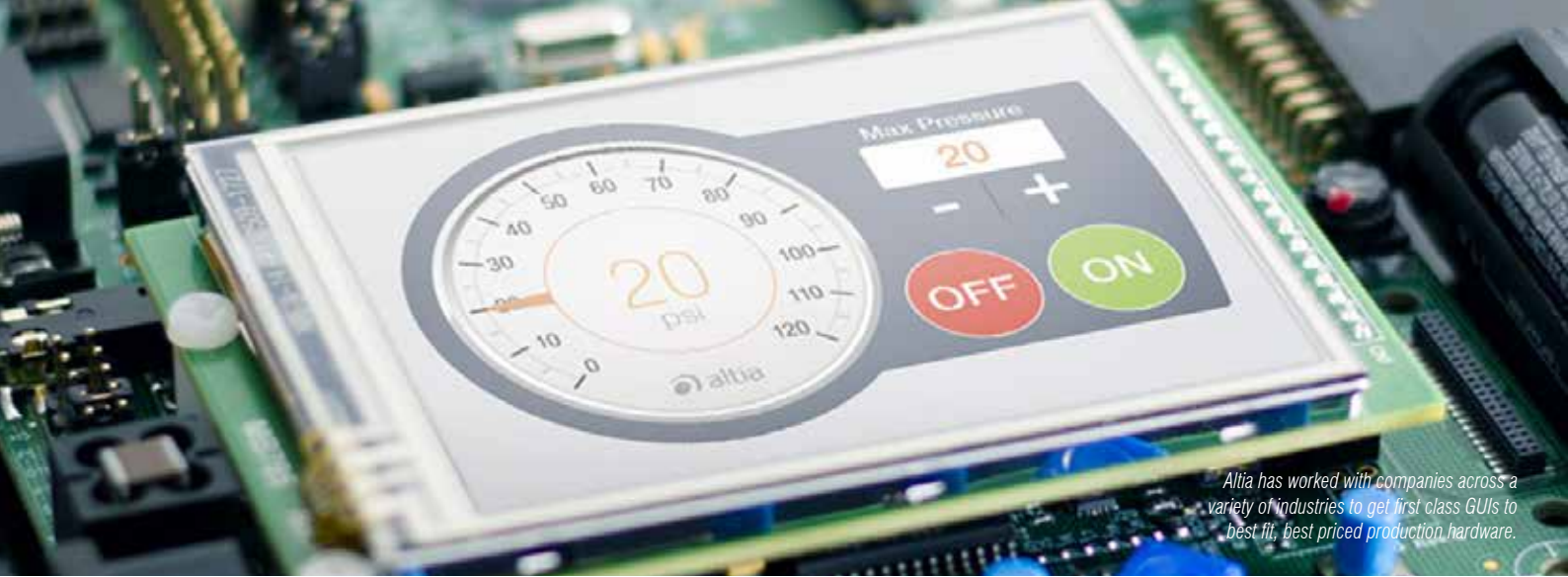

Altia has worked with companies across a variety of industries to get first class GUIs to best fit, best priced production hardware.

The Challenges of Creating User Interfaces for Mass Market Devices



Products with embedded displays – especially those with touch screens – are more prevalent now than ever before. We see and use these devices every day. Small hand-held devices like fitness trackers and blood pressure monitors, home appliances like washing machines, coffee makers and stoves, plus countless other products – sewing machines, media players and more – are difficult to imagine without their colorful, useful, smart-phone-like embedded displays. As the Internet of Things (IoT) expands, this trend will snowball and products with graphical displays will proliferate because the “Things” that are receiving information from the internet will require an intuitive means to communicate that information to the user. In turn, the same user will need a way to interact with that device. The embedded display represents that communication point – and an entire market of microcontrollers and Systems on Chips (SoCs) has been created to target these applications.

But how does a company experienced in the inner workings of a medical or consumer electronic device add a Graphical User Interface (GUI) to their product? The development of a GUI for these devices can be a monumental challenge for inexperienced companies and service providers because these projects involve a group of complex tasks – creating the graphics, developing and testing the GUI model and,

finally, delivering that GUI to the right hardware for production. In this article, we will discuss the challenges involved with each task and discuss how Altia user interface development software can be a key component for a cohesive solution.

Creating the graphics

What will the product actually look like? How will those graphics be created – and by whom? How do developers even get past the first step?

For a production GUI application, graphics are typically generated by an industrial designer using tools like Adobe® Photoshop®, Illustrator® and After Effects®. Once these graphics have been evaluated and accepted by the GUI team, a GUI developer must program these carefully-crafted graphics into the desired locations in the GUI display.

Implementing the artists’ concepts to the user interface faithfully is one of the biggest challenges in embedded GUI development. It can be difficult to match the artwork originally drawn in a graphics tool on a Mac or PC to the user interface being modeled to run on an embedded system. Ideally, the user interface should be a pixel-for-pixel replica of the original artwork so that there is no loss of graphical intent or artistic vision. This is potentially one of the most difficult development steps to get right – and it is incredibly time-consuming, especially given the likelihood of multiple graphic- and screen iterations. Companies can shortcut this process by using a software tool suited to extracting graphics from industry-standard tools.

Tools like Altia PhotoProto automate this task for artists and GUI development teams. PhotoProto is an Adobe® Photoshop® plug-in that efficiently clips out artists’ graphics from a single Photoshop Data (PSD) file. During the extraction process, PhotoProto trims the images to remove unnecessary pixels, which helps to preserve the limited memory resources available in an embedded system. PhotoProto also generates an Extensible Markup Language (XML) description of these extracted objects. This XML is useful in the next step of the GUI development process, which is to place the various GUI objects in



Fig. 1 - Altia PhotoProto perfectly trims static Adobe® Photoshop® graphics, converts them into interactive prototypes and prepares them for further development in Altia Design.

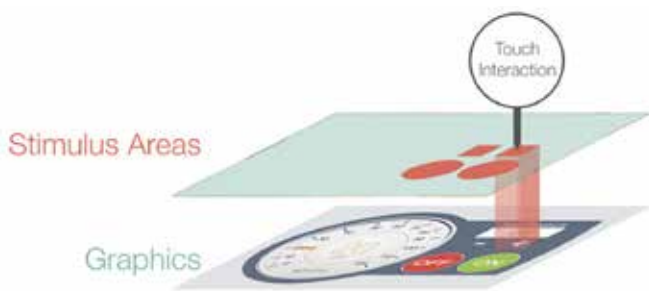

Fig. 2 - Altia Design allows developers to assign stimulus to objects in a GUI so that the GUI will react when the user touches the device screen.

their desired locations in the GUI model. Reusing these assets at every step along the chain – not having to recreate them by hand at different stages – is key to delivering a GUI that looks like the artist intended.

Developing and testing GUI models

So, assuming the static graphics have been perfectly exported from the artist's tool and that their screen positions have even been defined thanks to the XML data, how do we actually bring the interface to life?

Graphics libraries

Using graphics libraries, developers can start to create a GUI by hand-coding the components into their interface. Each graphics library comes with its own advantages and disadvantages – such as speed, ease-of-use, hardware acceleration efficiency, etc. Different graphics libraries are needed during prototyping and in the final embedded hardware, so developers must take care to understand the differences between the graphics library used in the simulated system versus the one for the production-intent hardware.

Another consideration when selecting a graphics library is that it may require a more powerful CPU and greater memory in the production-intent hardware, simply due to the type of graphics library that is chosen. The cost of an SoC increases the Bill of Materials (BOM) right from the beginning of a project and carries it through for the life of the product. This cost, which can be incurred almost exclusively because of the graphics library chosen, might be overkill for the complexity of the intended GUI.

Additionally, developers must be aware that the embedded graphics libraries may only be available for a limited number of hardware platforms. While a particular graphics library may offer a tremendous advantage in development speed, its selection can limit the available hardware choices later in the product lifecycle.

Likewise, considering efficiency from the beginning is important. One of the most common mistakes made by GUI developers is to underestimate the power needed to drive animations and graphics. Experience shows that, by the end of the project, every CPU cycle is necessary. Developers must be prepared to take advantage of hardware acceleration when it is available, since hardware acceleration offloads precious cycles from the CPU.

Simulating and testing

It is also important to consider how the interface should perform and respond to the product's functionality. Simulation experts spend countless hours developing software simulations to ensure that their products function correctly and without error. The data provided by simulations, however, is not easily understood by customers, user

experience professionals, executives and others. Yet it is the feedback from these very groups that is vital to make embedded devices the best they can be.

By creating a GUI model, developers allow for testing and actionable feedback to help prove, and then improve, the user experience of products. A key method for quickly and efficiently developing GUI models is to use a WYSIWYG (What You See Is What You Get) GUI editor, like Altia Design. Graphic editors can be used to lay out the GUI, integrate the GUI model with simulations developed in modeling tools from MathWorks® Simulink® or Stateflow®, IAR Embedded Workbench® or similar tools, and get a working GUI model running on the simulated system. GUI models can be shared with customers, for example, to prove use cases and help perfect user experience.

Just as the developer can generate movements or transformations on GUI objects using keyframe animation, he can also assign stimulus to GUI elements in Altia Design. Stimulus tells the objects to react when the user touches the screen. All the underlying hardware dependencies involved in processing the touch controller are abstracted away from the developer and are covered by the late code generation.

Connecting to C code

But what if the developer does not have a simulation – or is connecting the GUI to the actual C code that will be deployed on hardware?

This situation is usually resolved by using an Application Programming Interface (API) to drive the objects in the interface. With Altia's software, for example, the state of GUI objects at design time has been linked with Altia Animations. Altia Animations are combinations of unique identifiers and the keyframes of the respective states of motion. A simple and clear API allows developers to change the state of a GUI object directly from the application or by querying this state from the GUI. There are also corresponding APIs which signal a state change of a GUI object in the application, like when the user has touched an

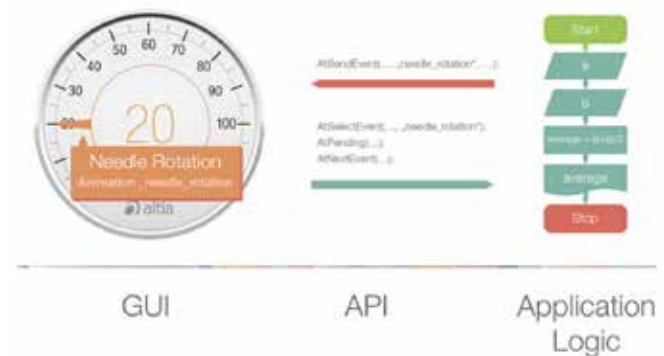

Fig. 3 – Using an API, developers can add a GUI to an existing application by adding just a few simple API function calls.

object on the screen. The developer has full control of the functional sequences of his application code – when the application queries or changes the respective GUI objects, as well as when the applied changes of the GUI should be displayed on the screen. With this functionality, developers can add a GUI to an existing application with just a few simple API function calls.

Whether connecting to a simulation or to C code via an API, a connected GUI editor allows designers to create a working model of their GUI and distribute it via a runtime environment to stakeholders early enough in development to collect actionable feedback. This process allows for



Fig. 4 - By allowing the connection of external tools that help define the application logic in parallel to the corresponding GUI parts, a connected GUI editor allows developers to develop and test in an agile manner.

quick iterations before the product goes to hardware. This thorough testing of the user experience puts developers in a good position for when they take the next step and get something running on the embedded hardware.

It is important to test this interaction early and often. During the entire design process, the GUI in Altia Design can be driven by user interaction or external events, exactly as it would on the embedded hardware. By allowing the connection of external tools that help define the application logic in parallel to the corresponding GUI parts, a connected GUI editor allows developers to develop and test in an agile manner. A simple example is a connection from Visual Studio to Altia Design, which can help with the development of parts of the application on the PC. Even on the PC, the application logic will use the same API to interact with the GUI as it will later on the embedded system. Since native C is used as the development language on the PC, it can be directly used on the embedded system in parallel to the GUI code generated. And, since it has already been tested against the GUI model, much of the testing work is already done. Using this approach, implementing and testing the GUI-plus-application logic is possible all along the development cycle – independently of the final real hardware. Therefore, the GUI development can be started early and run parallel to the hardware development.

Delivering GUI to hardware – and then to production

Now that the GUI is laid out with beautiful graphics and the user experience has been fully tested, how do developers transfer that same model onto their production hardware?

The embedded hardware used for a GUI must consider several necessary components, including:

- A color TFT (Thin Film Transistor) display
- An external touch controller
- External RAM for the frame buffers, which store current display content
- External Flash for non-volatile storage of images and assets used in the GUI (since Microcontroller Unit (MCU)/SoC internal Flash is often not large enough)

Beyond selecting these components, developers must determine whether the hardware is the right match for the planned GUI. One common step is to obtain an evaluation board and its corresponding board support package (BSP) as provided by the silicon vendor. These boards and their design documents (schematics, layout, BOM) help the developer to evaluate the hardware for their GUI project and then design the custom GUI application hardware. Ideally and if time allows, multiple evaluation boards will be evaluated at project start to select a board with the right combination of price and power.

For some teams, this hardware selection becomes the breaking point

for their product GUI. If they are hand-coding their graphics, then it is not only time-consuming but nearly impossible to get their artist's original vision onto the hardware. If the GUI design is not balanced with the capabilities of the selected hardware, the GUI performance suffers, thereby delivering a poor user experience. If an expensive, over-powered processor is selected for a simple GUI, the BOM cost drives up the product price and the product suffers in the market.

A graphics code generator, such as Altia DeepScreen, offers a straightforward solution for delivering a pixel-for-pixel replica of an Altia GUI model to the final embedded hardware. Additionally, generating code with DeepScreen in parallel to GUI design provides development teams with a better understanding of how their GUI performs on the hardware. Developers can make decisions before finalizing the production hardware that allows them to balance their GUI design, its performance and the hardware price.

DeepScreen converts the same Altia model used during development, simulation and testing – by converting the user interface model to native C code. Altia DeepScreen supports an array of hardware, from low-powered chips to full-featured, 3D-capable processors. Each DeepScreen target is carefully architected to leverage all the on-chip assets of the selected processor.

All potentially-available hardware graphics accelerators are leveraged. Since the complete C code for the GUI implementation is visible to the developer, it can be debugged right down into the details of the GUI, if this should become necessary. Another important aspect of having access to the GUI's C code is to support the analysis of the code which might be embedded into safety-critical applications, such as medical devices.

Delivering an embedded GUI for production

Connecting a first GUI to a simulation or to the hardware generates a host of challenges: from getting the graphics right to developing the product logic; and from selecting the right hardware to delivering a useful, beautiful, performant product to market.

For more than 25 years, Altia has been a partner in this process with companies in the automotive, medical, consumer electronics, home appliance, industrial and fitness industries. Using Altia tools, teams numbering from two to 200 members have successfully deployed GUIs for production. Having the right tools and expertise is a big part of that success.

About Altia

Altia as a company is geared towards helping companies to achieve best-performing graphics on the best fitting, best price hardware for their product. With Altia, developers can select hardware from silicon providers like Cypress, NXP, Renesas, STMicroelectronics, Texas Instruments and more. Altia provides a proven GUI development solution which allows design teams and developers to quickly design, develop and deploy a GUI for their embedded applications. For teams who need a jumpstart for their GUI project, Altia also offers Professional Engineering Services. Altia's Services team can assist with all aspects of embedded GUI development – from planning and prototyping, to graphics creation and story boarding, from design, development and testing through to hardware integration and product updates. For more information about Altia, visit www.altia.com or email info@altia.com.

Jason Williamson, VP of Marketing, Altia

The practicalities of virtual system analysis

PART 1

The following article is in three parts. This first part describes Advanced Integrated Engineering Solutions' system analysis framework while the second part, which will be published in the next issue of the EnginSoft Newsletter describes the abstraction techniques the company uses to aid large system analyses. The third part, which will be published in the subsequent issue of the EnginSoft Newsletter, introduces the company's tribology solutions (or joints) for machine design.

The current design procedure used globally generally inhibits good practice of collaborative working and fails to fully maintain product design quality. This is because of the use of disparate products for Computer-aided Design (CAD), Computer-assisted Engineering (CAE) and Product Lifecycle Management (PLM). While I concede that some vendors offer their own complete solutions, this is based on customers using that vendor's own disparate products and aims at monopolizing the design process; it offers little solace to companies that use different vendors' products for different physical solutions.

System analysis framework – the need for a standard for CAD and CAE

The process we have invented means that a design cannot be signed off without the analysis being verified, but still allows the designer to achieve a collaboration between vendors' software so that best-in-class analysis procedures can reside together in one environment. This is a novel approach because it builds on the proven foundations of solid modelling and meshing being combined and formulated in a new object-oriented way.

Our process democratizes the design process and allows all stakeholders to participate in the design at the right time. The design process is completed once the design has been optimized or meets

its predefined criteria, and not when a superior insists that drawings should be released to meet his milestones. This custom is almost never good for the company and can often lead to embarrassment and monetary losses for those involved, not to mention the anger and frustration that is felt by the engineers and specialists that are overlooked in this risky decision.

The creation of drawings for manufacture are, rightfully, downstream of the design process while for us at AIES Ltd, design includes CAD and CAE. Our process combines the solid, geometry and physics, which means that it lends itself to design synchronization and a much-needed standardized approach.

The history of SystemDesigner and SystemDeveloper

From 1997 to 2000, I worked for Federal Mogul R&D and initiated and ran a project with Romax, to develop a prototype, object-oriented Valvetrain design system which used AVL, Ricardo and in-house engine design and analysis tools. My brief was to make them much more user-friendly.

From 2000 to 2003, I worked for AVL as Director of AVL AST UK where I started an initiative for whole-engine friction simulation to predict all components, subsystems and total engine friction prior to engine testing. I then left AVL and founded AIES Ltd to pursue my own brand of software and analysis techniques. At this stage, I re-started the whole-engine friction simulation project with FORD, to predict all components, subsystems and total engine friction prior to engine testing. We devised EngineDesigner, a whole engine friction tribology prediction system, between 2003 and 2005. This was validated against three engines supplied by the customer. The project was in three separate parts: a) Valvetrain system, b) Power cylinder system and c) Crank train system. I decided that while we would concentrate

on the Valvetrain system, we would continue to offer other systems once we had developed them. We went on to win the Valvetrain system tender, beating off stiff opposition.

EngineDesigner is a technology demonstrator for our SystemDesigner environment. It includes analytical solutions, Short Bearing Approximation (SBA), Short and Long Bearing Approximation (SALBA) and Elasto Hydrodynamic Lubrication (EHL), plus numerical solutions for Rigid Hydro Dynamics (RHD) and ElastoHydroDynamics (EHD), and it considers Inline 1 – Vee 12 engines in gasoline or diesel, either 2- or 4-stroke. (Part 3 of this article will discuss more about AIES's engine/machine tribology solutions.)

In 2007, I invented Finite Objects (FO), which combine solids and meshes, and the architecture of SystemDesigner and SystemDeveloper and began the

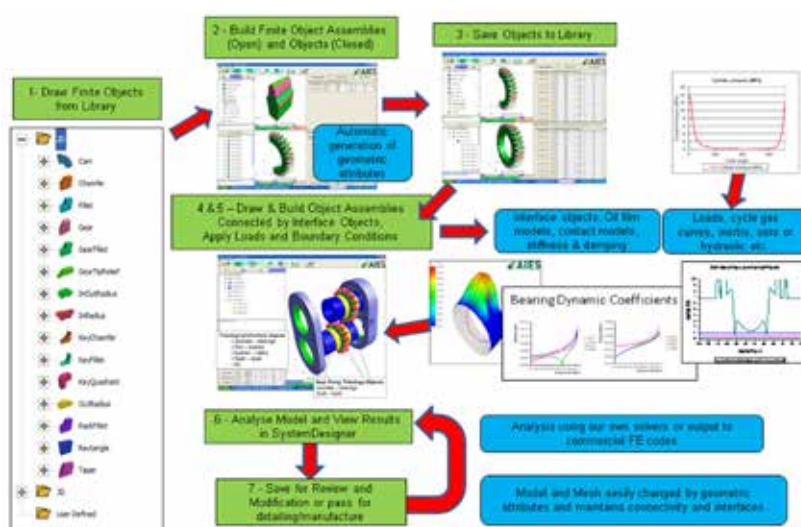

Fig. 1 - The SystemDeveloper Process illustrated

patent process with the UK, Europe and the US which was granted in 2014. Finite Objects are the basic building blocks that use the solid model and hexahedral mesh fused together. Specific connectivity and operations permit a vast number of objects (components) to be built. These objects can be used for Finite Element (FE), Finite Volume (FV), Finite Difference (FD) and Boundary Element (BE) meshes and solvers. Currently for Finite Element Analysis (FEA), the software outputs the solid and mesh to Abaqus, but has its own MultiBody Dynamics (MBD) solvers which will also be discussed more in Part 3. Connectivity to other vendors' solvers and software can be further increased once we have buy-in from them – something in which we have made slow progress to date since they seem to be preoccupied with additive manufacturing and all it entails.

SystemDesigner can build solid, mesh and physics into assemblies for realistic simulations. It includes abstraction techniques for 3D solids to 3D beams with very accurate shear correction factors, and 3D solids to shells. It also has techniques to abstract oil films (analytical and numerical) to stiffness and damping coefficients (springs and dampers) for use in reduced MBD and rotor dynamic simulations. This will be covered in more detail in Part 2 this article.

Figure 1, below, shows the SystemDeveloper process that withdraws finite objects, the basic building blocks, from their library. It then builds finite object assemblies and objects and saves them to relevant libraries after which it builds up assemblies -- say a crankshaft on its main bearings -- withdrawing objects (crankshaft and main bearing assemblies) and interface objects (oil films) from the library, and goes on to assemble the models (objects) together.

After defining the model, it is still necessary to define the loads acting on the model which have been derived from gas and inertia loads. In EngineDesigner, this is automatically defined by the gas curve and the inertia and masses of the components. EngineDesigner analyses the model to check the crankshaft is strong enough and whether the bearings have large enough oil films etc. If acceptable, the design can be signed off and released for detail drawing and manufacture. If not, the design must go around the loop again.

The process demonstrates how easy it is to change the geometry and the mesh because specific geometric attributes and advanced meshing methods are built in to allow biasing and mesh enhancement where they are specifically needed, at kt features and joins in different materials, etc.

Tools to develop and build design environments

This approach or method came about after many years of using commercial Finite Element (FE), MultiBody Dynamics (MBD) solvers of other companies, where the methods were either very specific or too general to model real machine behavior. I thought that there should be a better way of doing it all, and so I invented Finite Objects, SystemDeveloper and SystemDesigner, and other things along the way.

Part of the problem in system analysis is understanding what is reusable across disparate industries to create a truly generic approach. While MBD, FEA and Computational Fluid Dynamics (CFD) have many things in common, the way they are packaged often misses the point of what all we engineers are trying to do, namely design things!

This process should be as painless as possible since we cannot all spend 100% of our time sitting in front of a CAD or CAE workstation. So sometimes, if the software is not intuitive, it requires the engineers to go through another steep learning curve each time they return to it, even after only a short break, as they try to remember where a function or command is to be found in the software interface. To this end, we have painstakingly made our software very user-friendly and intuitive to aid user productivity.

Our SystemDesigner and SystemDeveloper environments allow an engineer to build object assemblies and save them to be executed in the SystemDesigner environment. This houses methods, standards and expert knowledge for use by other engineers to carry out controlled system analysis having many aspects of multi-physics at their disposal. For example, the engine design process might resemble this: combustion, cycle simulation, conjugate heat transfer, stress and displacements, tribology, durability (wear and fatigue). The idea of the software is to model the real physics of the machine, using what is, in fact, a Knowledge-Based System (KBS).

We supply tools that allow companies who know their processes to tailor their design environments to their own methods or to develop their own, building their data input, analysis tree (methods), and results and reporting. Our methods are very promising, but we need better buy-in from FE, CFD and CAD vendors, and we are looking for external investment and funding since all the development to date has been self-funded.

What do knowledge-based systems offer?

Firstly, they allow company knowledge capture and then provide a safe repository for Intellectual and Industrial Property, IPR, R&D processes

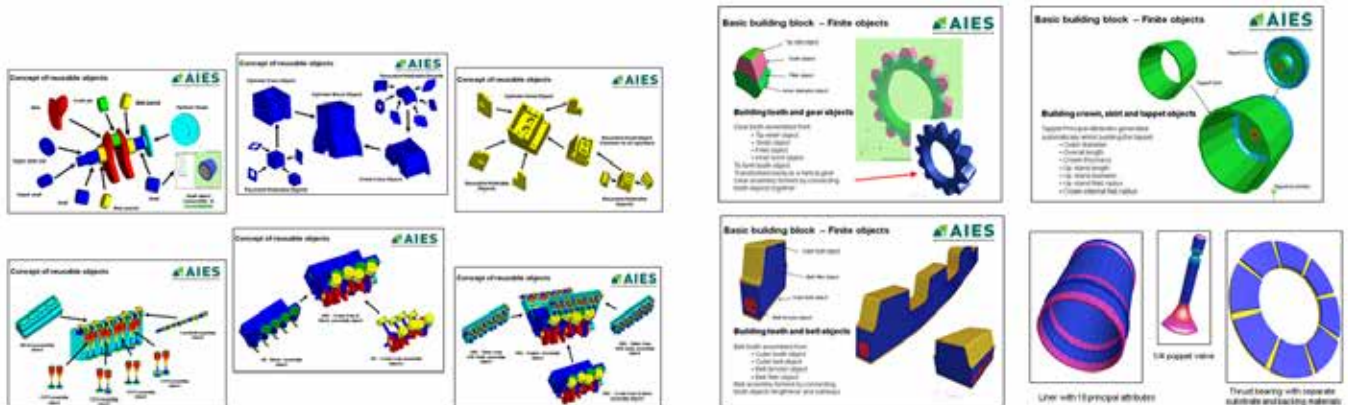

Fig. 2 - LHS Concept of reusable objects – don't reinvent the wheel. RHS – various objects built in SystemDeveloper

-- in short, all company knowledge. They permit the standardization of design and analysis procedures and enable reusability and flexibility, while allowing the building of new objects, system templates, methods and, of course, new products.

Our 3D modelling provides the mesh as a by-product of abstraction choice. The object's principal geometric attributes are automatically generated and these drive automatic geometry changes. Our design iteration methods capture design intent and analysis history and capture the design evolution. Our methods of results processing allow comparisons between test, predictions and targets and between different systems.

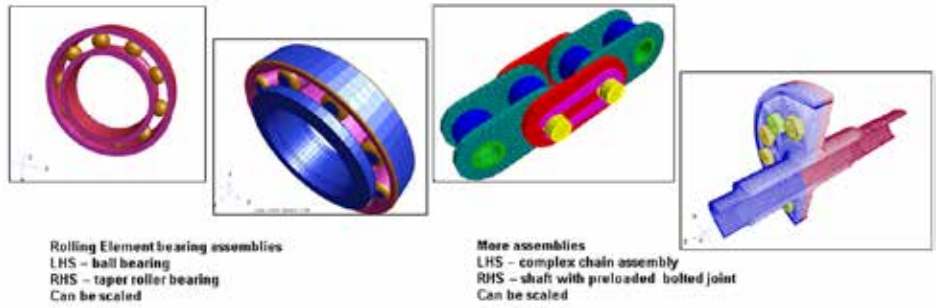

Fig. 3 - shows different object assemblies that can be scaled to form catalogues of components

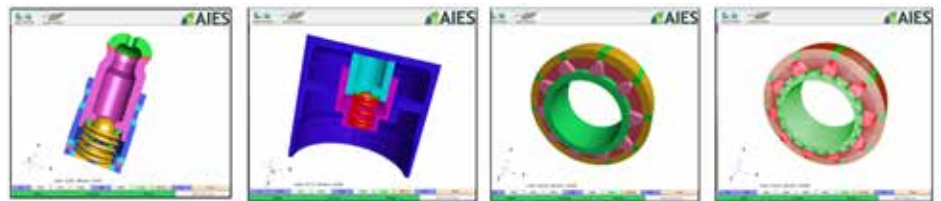

Fig. 4 - LHS Finger follower and bucket tappet hydraulic lash adjusters. RHS involute spline assembly.

The left-hand side (LHS) of Figure 2 shows the concept of reusable objects (components) and suggests that you don't have to reinvent the wheel. It indicates how a seemingly complex system (engine) can be derived from quite simple concepts. The right-hand side shows examples of objects built using our methods. Also visit www.aiesl.co.uk for more examples.

The basic building blocks – finite objects

There is a library of finite objects (as shown in figure 1) that can have any shape and any number of sides, for example, a cam, gear, or fillet, and that can be either 2D or 3D. Finite objects are described with interface surfaces and connection surfaces. The interface surface is a public connector as it connects to other objects, via interface objects (called joints by other people). Interface objects can be oil films, contact, stiffness and damping coefficients, or bonded and tied contacts.

Connection surfaces are private connectors and pass data in the form of material, geometry and mesh. Objects are built by manipulation and connecting finite objects (FOs) to form solid objects, for example, gear teeth, gear assemblies, tappets, liners, poppet valves, timing belts, chains etc. As you build the solid, the mesh, being fused to it, is created automatically, so no additional meshing operations or software are required in our process. When the model is passed along to the next process, the engineer can edit the geometry, the material and the mesh in one environment. This is really novel.

What is needed for a CAD – CAE standard?

The Initial Graphics Exchange Specification (IGES), Standard for the Exchange of Product Model Data (STEP) and other translation standards do not fully define both geometry and the mathematical representation (mesh), so disparate geometry and mesh definitions are used in today's CAD-CAE-PLM solutions, and there is, unfortunately, no agreed approach to standards. In our approach, the mesh is an integral part of the solid -- the designer, analyst or engineer can change and edit both in the same

environment. Moreover, as the solid models are built, geometric attributes are derived for objects by summing up the attributes of the finite objects forming the solid. Additional features are the material or physical properties for each FO making up the object (component). Therefore, different materials can reside within the same object, and the mesh can easily be enhanced or biased at the connection between FOs.

One example already shown is the timing belt finite object assembly which contains rubber (elastomer), fiber-glass, and reinforced glass-fiber rope. Another example is the thrust bearing which has a steel backing and a babbitt or phosphor bronze bearing material. We can also use this feature to model case-carburized gears or components; it just needs to be planned into the model.

Building objects and assemblies – chains, bearings, shafts, and splines

Figure 3 below shows the object assemblies of a ball bearing and a roller bearing. The right-hand side (RHS) shows a chain sub assembly with pins, links, bushes, rollers and even the retaining clip, all of which can be scaled to form catalogues of components and assemblies.

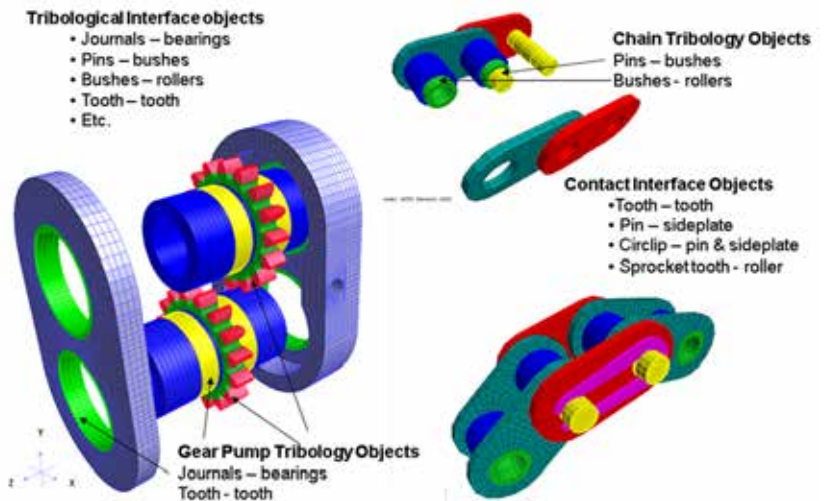

Fig. 5 - various assemblies and tribology interfaces

Note that they are meshed automatically as the solids are built. The extreme RHS shows the half section of a bolted joint between two half shafts. While this can be used for a modal analysis to capture the bending modes, the whole shaft model is necessary to calculate the torsion modes.

Figure 4 LHS shows a finger follower Hydraulic lash adjuster assembly, solid and hex meshed, whose assembly consists of the housing, piston, ball, retaining cap, and return spring. Figure 5 shows further examples of assemblies with interface tribology objects. LHS shows an application of a gear pump concept, the RHS top shows a chain with tribology interfaces; the bottom RHS shows our contact interface objects: Pin to side plate, Circlip to pin, Circlip to side plate, and Sprocket to roller/bush.

Meshing and transformations – how the solid and mesh are fused

Each Finite Object (FO) has its own mesh pattern built in, so that it is part of the solid. There are specially defined methods of connectivity,

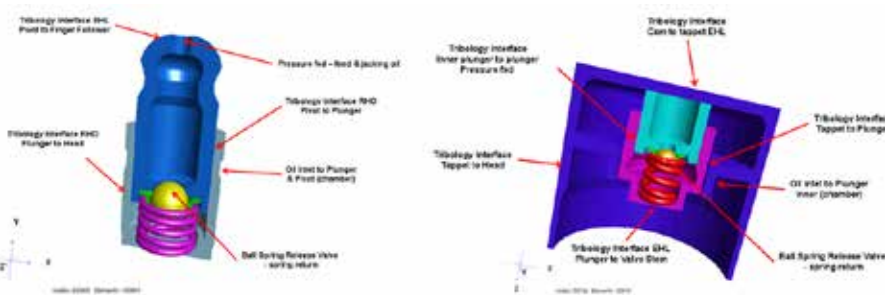

Fig. 6 - finger follower and bucket tappet tribology interfaces

as already explained. These ensure the mesh is always updated when it is edited. The meshing operations for each FO can increase density (by a factor), coarsen mesh (by a factor), bias the mesh from the top or bottom, or in both directions, and add uniform cells for CFD boundary layers.

There are numerous transformation operations, including: mirror, flip, extrude, revolve, revolve with offset, sweep, helix, shear and form. While this list will be extended in future versions, we have demonstrated the variety of objects and components that can already be constructed easily.

Complications of real-life system calculations – a need for abstraction

Designing and analyzing real systems in 3D requires an awful lot of memory and cloud space, e.g. the small hydraulic lash adjuster assemblies we discussed earlier. Figure 6 shows the tribology interfaces of the finger follower lash adjuster assembly and of a hydraulic tappet lash adjuster assembly. Multi-cylinder and multi-valve engines will have a considerable number of these tappets, which means that the ability to abstract the tribology interfaces would be extremely beneficial, although there would be a lot of oil films to simulate for MBD and tribology calculations. This is perhaps why some engineers and consultancies use approximate stiffness and damping values instead, having derived them over many years by test and experience. In contrast, our methods and science mean they

can be accurately derived, without testing. Tests should be used as a means of validation and learning.

Our software can abstract the stiffness and damping values based either on load displacement EHL calculations, or on our bearing stiffness and damping coefficients derived from our SALBA and RHD oil film models. These will be further explained in the third part of this article.

Conclusions

You may ask why the solid modelling should be developed fused together with the hex mesh. In the first place, the solid, geometry, materials and mesh are then truly synchronized into the design process. In MBD, it is possible to use multi-fidelity models, for example oil films, EHL films, and stiffness and damping coefficients derived from our oil film models; and 3D solids reduced to accurate 3D beams and shells, derived from 3D FE models, so that stresses can be more accurately defined when substituted back to the 3D solid. Our process ensures the design cannot be signed off without the correct analysis having been carried out, whilst still offering collaboration between software vendors.

This means best-in-class solutions can be used by engineers and companies in a truly integrated design process. For example, the user may want to use Abaqus for stress and dynamics FEA, CFX for CFD, Maxwell for electromagnetics, and, perhaps, Star CD for combustion. Our methods allow this democratization of the design process (including multi-physics analysis) for the engineers and their companies. While the creation of drawings and manufacturing are

downstream of the design process, they are not neglected at all during the design phase, but are, rightfully, given the correct emphasis – they are not the be-all and end-all, despite what some people would have you think.

Since our process combines the solid, mesh, geometry and physics, it lends itself to a standardized approach. Our user-friendly solid modelling, building and analysis methods allow KBS methods to be seriously considered as a sensible alternative to the PLM methods used today. This would require designers to learn to use and build KBS systems. Once we have buy-in from other vendors, we can further increase the connectivity to their solvers and software. Progress has been slow in this regard because they seem to be preoccupied with additive manufacture and all it entails.

*By Dr Ian McLuckie, Managing and Technology Director for Advanced Integrated Engineering Solutions Ltd**

*** Advanced Integrated Engineering Solutions Ltd is based in Market Harborough, LE16 7HG, Leicestershire, UK. Dr McLuckie can be contacted at email: ian.mcluckie@aiesl.co.uk, or via the web at: www.aiesl.co.uk**



Ergonomic simulation – investing in greater company competitiveness and improved productivity



Safeguards the health and satisfaction of the workforce in production lines, too

Workplace ergonomics

We spend the major part of our time in the workplace, so the environmental conditions in which we work are critical. Many larger companies have already recognized the importance of office ergonomics and experience shows that taking just a little care to apply simple ergonomic measures can improve both worker satisfaction and work efficiency.

How can comparable results be achieved in workplaces where physical



work is done? The workers in these jobs are under constant time and performance pressure. How can the various parameters of their workstations and the whole work process be optimized to shorten work-cycle times and simultaneously improve the levels of worker satisfaction? How can we protect our most important resource -- the human workforce -- while maximizing its performance?

Challenges in the manufacturing industry

Production companies are confronted with some typical problems of our times, including aging populations and labour fluctuations and shortages, and must solve the corresponding challenges and difficulties. The protection of employees' health has become a central issue; the risks of musculoskeletal disorders and occupational accidents must be reduced. The rapid development of technology pressurizes companies to innovate, which comes with additional costs, yet companies still need to remain competitive. However, there are disturbing factors that prevent worker concentration, create stressful situations and slow down work processes. Unnecessary strain causes pain in various parts of the body and has serious health effects. If the tension in a body part regularly exceeds a certain threshold, it leads to diseases that require long-term treatment resulting in a significant loss of working time. Frequent sick leave and,

consequently, the training necessary for new or replacement employees generate significant additional costs for a company.

The solution is simple. Optimal working conditions have to be created to ensure a reliable and efficient production process. Often just a few simple changes are sufficient. This objective can be achieved with ergonomics, a scientific discipline, and some modern technology.

Traditional ergonomics

As a discipline, ergonomics has always had a rather peculiar relationship to technology. Glancing through its history, it becomes clear that this field has always been rooted in methodologies, databases, guidelines and principles -- in short, academic knowledge.

Because of its history and the strong dependence on other fields of technology, ergonomics experts are inclined to use traditional methods and approaches during ergonomic assessments. These usually consist of checklists, risk assessment sheets, guidelines or other techniques that use paper and a pencil. Paper-based information or evaluation has been around since the birth of ergonomics, which dates back to the first anthropometric databases created for military purposes.

These risk assessment methods usually incorporate some sort of scoring system, which determines the overall ergonomic adequacy of a given workplace. This numerical categorization provides a somewhat objective system that helps ergonomists to identify possible deficits and to compare the ergonomic appropriateness of different workplaces with each other. The final score is based on numerous factors, which may concern the work environment, the working postures, the work tools or other aspects, depending on the comprehensiveness of the method. The RULA (Rapid Upper Limb Assessment) sheet for example focuses mainly on body postures, whereas the EAWS (Ergonomic Assessment Worksheet) considers an extensive range of factors during evaluation. This means, however, that the scores of different assessment methods cannot be compared with each other, as they are derived from highly distinct calculation processes.

Another disadvantage of these techniques is that they are only applicable to existing and well-established work tasks through a framework of so-called "corrective" analysis. This means that a workplace that is still being designed cannot be evaluated, because there are not yet any tangible sources of information regarding the working postures and movements, or even the work environment. So, paper-based ergonomic risk assessments cannot be incorporated into the early phases of a workplace development project.

Despite the disadvantages, these traditional risk assessment methods (like RULA, OWAS, EAWS) have not become obsolete because they provide ergonomists with more or less unbiased scoring scales to evaluate workplaces. What has become obsolete, however, is the way the data is gathered for the calculation of the scores. Most of the factors that determine the final score require accurate data to ensure the authenticity of the evaluation – such as in the REBA (Rapid Entire Body Assessment) risk assessment where the position of the body segments primarily determines the final score. However, the established method among ergonomists is to simply observe the worker over several work cycles and then estimate the effect of the specific factors.

Another similar approach consists of recording the work task on camera and then analyzing the recording using still frames to find the most inconvenient postures and measuring the position of the body segments with a ruler and protractor. Not only is this method inefficient but it is also inaccurate because it is impossible to measure the exact angles of a 3D human's posture on a 2D photo.

Virtual ergonomics

An accurate ergonomic analysis requires objectively measured motion data. The Xsens motion capture system has been developed to measure and record the movements of the whole body. The equipment works with inertial sensors, biomechanical models and sensor fusion algorithms. The suit is non-obtrusive, ensuring that the workers can move naturally and realistically. The motion capture system can be used in all environments, including industrial plants with lots of magnetic interference; the motion capture data will not be affected.

While the motion capture equipment registers every detail of the movement in a realistic, fast and objective way, it does not answer the following questions: whether the frequently repeated body positions are comfortable or at least acceptable, whether the loads on the different parts of the body are within the acceptable limits, or whether the health of the employee is endangered in the long run.



ViveLab Ergo

ViveLab Ergo was developed by ergonomics experts and is based on more than 30 years of professional experience in the fields of software development, human simulation and ergonomics.

This cloud-based ergonomic simulation system is perfectly capable of modeling and analyzing machines, robots, and people moving in a given physical environment more precisely, faster and more easily than ever before. Harmonizing the co-operation of these three elements is an indispensable task in the Industry 4.0 era.

The software uses an extensive anthropometric database to realistically model the geometric features of 99% of the human population. The simulation can be carried out for any nationality, gender, age group and body structure.

Seven internationally known and recognized ergonomic analysis methods have been integrated into the ViveLab Ergo Software. These methods include RULA (Rapid Upper Limb Assessment), OWAS (Ovako Working-

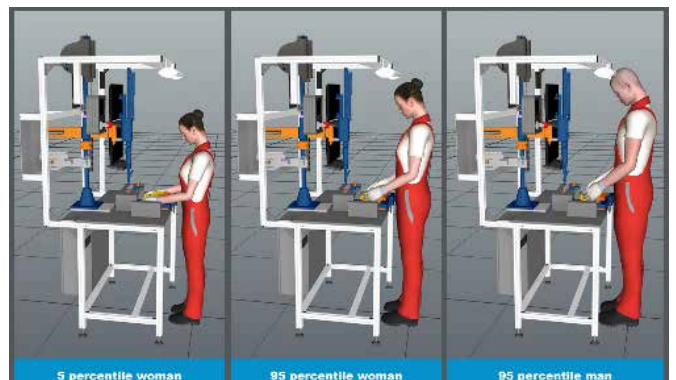

posture Assessment System), NASA-OBi (examines static physical forces affecting the skeletal and muscular systems) and the already standardized body position assessment systems, such as ISO11226 (evaluation of static working postures) and EN1005-4 (safety of machinery for human physical performance). Furthermore, the reachability test (measures the reach of the arms for the location of devices and objects) and the spaghetti diagram (measures the length of a journey by a worker) are also available. These methods evaluate the body postures and check whether the loads on different body parts exceed the acceptable limits. Some methods define only acceptable and unacceptable categories, while other methods use a scale of rating. Evaluation points are given based on each analysed factor. These are summarised at the end to indicate the risk category of the analysed object. This allows the user to determine the seriousness of the problem and the urgency of taking action.

The results can be seen in real time. It is also possible to create a PDF document of the detailed analysis with only a few mouse clicks. The report highlights the positions where ergonomic measures have to be taken to



improve the quality of the workplace. In addition to the corrective analysis of existing workplaces, ViveLab Ergo also offers ergonomic analysis of new constructions during the planning phase, without the necessity of producing prototypes, by conducting virtual simulations. All these steps can be performed independently by any user, even without a qualification in ergonomics. However, the company also provides a team of ergonomics experts that offer their services to help the users learn the software functions and to interpret the evaluation results.

The services of these ergonomics experts are available on request, and they make a significant contribution to successful outcomes. Thanks to the cloud-based software, the experts can be invited by the user from geographically distant parts of the world to collaborate in the user's own virtual laboratory. In this



way, they can carry out the analyses and interpret the results together. To eliminate the problems that were identified during the analysis, the ergonomics experts will create an action plan that includes the necessary and recommended ergonomic measures with suggested deadlines. The action plan can include different possible solutions. The user can select the solutions from the action plan that best meet their goals and are within the company's financial framework. Upon request, the entire process -- from the inspection in the production area through the motion measurement and analysis up to the evaluation of the results and the elaboration of the necessary measures -- can be carried out by the expert ergonomics team. The ergonomics experts can also optionally check which workplaces can be automated or where it is possible to employ ageing workers or workers with altered work abilities.

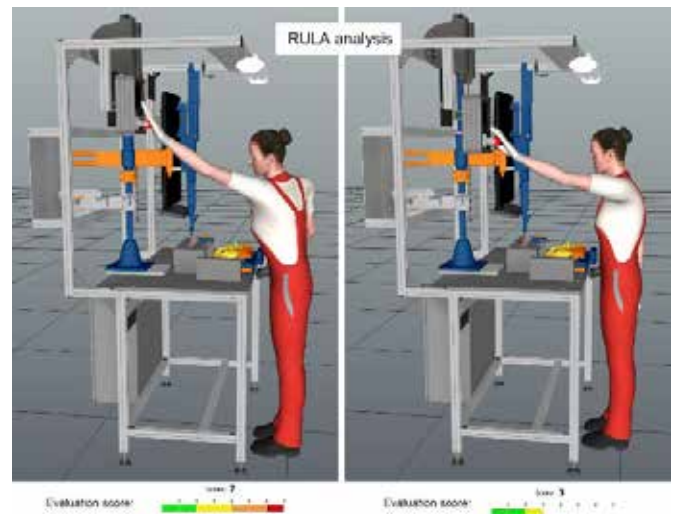

Conclusion

A satisfied employee can work in a concentrated, motivated and productive manner. A well-designed workplace that meets ergonomic requirements allows for comfortable and painless work. By optimizing workplace performance, reserves can be activated and productivity can be increased in the long run.

ViveLab Ergo is Sponsor of the International CAE Conference 2018

www.caeconference.com



EnginSoft and the European Space Agency investigate hydroponic plant growth for future space missions



The ACSA Project

EnginSoft has been collaborating with the European Space Agency (ESA) for the past ten years, working actively in the MELiSSA program. At present, this project's main efforts concern the life support system sector and the idea of creating an artificially closed ecosystem that generates food and oxygen for space crews on long-term missions. The current MELiSSA Pilot Plant (MPP), built to monitor the progress towards the goal, is located at the Universitat Autònoma de Barcelona. A 5-meter plant growth chamber, able to cultivate 100 plants and investigate their growth process, has been installed

At the MPP, the Air and Canopy Subcompartment Analysis (ACSA) project was implemented to study the impact of airflow on hydroponically grown lettuce crops.

Objectives

The main objectives of this project were:

- To improve the conditions in the growth chamber by re-engineering the air management system;
- To investigate the impact of airflow on plant growth.

Computational Fluid Dynamics (CFD)

Model of the system before the project

The 5-meter plant growth chamber was replicated using a CFD model of the complete system. This model provided deep insight

into the air distribution and the local environmental conditions around the aerial part of the plants.

The model highlighted a strongly unbalanced air distribution: the airflow was mainly located in the central region of the chamber, reaching peak velocities of over 1 m/s around the crops. These velocities, if sustained for prolonged durations, place harmful mechanical stress on the crops. Indeed, tests performed on the lettuce before the ACSA project found uneven plant growth, with

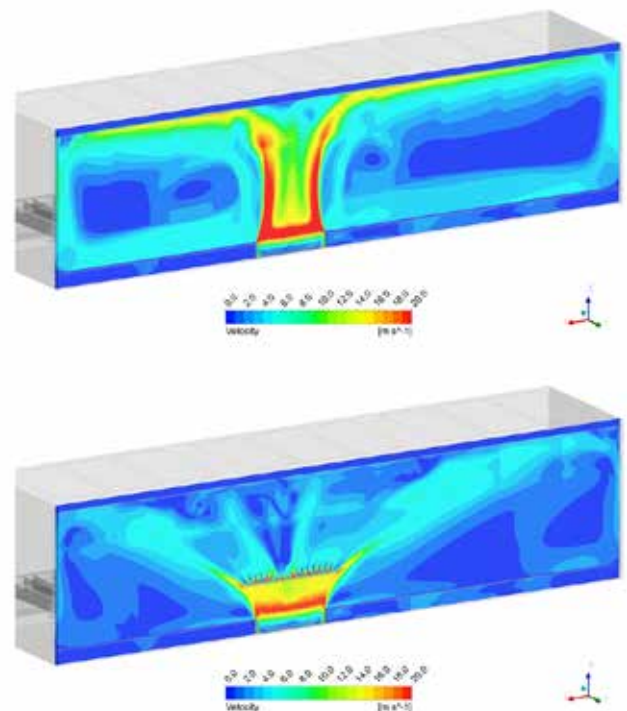

Fig. 1 – Air velocity contours before the project (top) and after the project (bottom).

a strongly reduced plant biomass in the crops cultivated in the central region of the chamber.

CFD Model of the system after the project

A detailed 3D CFD study supported the complete redesign of the air management in the chamber. Several components were added, and others were upgraded to create uniform air distribution around the growing plants. In particular, the CFD analyses enabled the design of a deflector which was assembled to impair the primary air flux by rearranging the perforated plates that are installed under the plant trays. In addition, some regulating components such as dampers were included to make the air distribution adjustable. These important modifications will enable the operators to perform new tests by changing the air velocity values to investigate their influence on various crops.

Figure 1 shows the air velocity field in the CFD models: the impact of the improvement -- making the airflow enter the chamber in a uniform manner -- is evident.

The modified air distribution means that the air velocity in the region of the growing plants can be maintained between 0.3 and 0.4 m/s. As a result, the crop tests measured an even growth among the lettuce plants.

At the end of the test, the operator weighed the dry biomass of each lettuce plant in order to compare them to past tests. The results are showed in Figure 2, which reports the histograms of the plant biomass before and after the ACSA project. The evenness of the harvested crops is demonstrated by the reduced standard deviation of the biomass test results.

Cameras were also installed in the chamber during the ACSA project to collect visual information on the plant growth at different stages in their development (Figure 3).

Conclusions

In summary, the CFD analyses performed during the project allowed the researchers to:

- Gain deeper knowledge about the conditions in which the plants are grown;
- Redesign the air management system in the growth chamber, to make the air distribution more uniform;
- Improve the resulting evenness of the harvest;
- Gain an insight into the plants' sensitivity to different airflow conditions.

For more information:

Sebastian George Colleoni - EnginSoft
s.colleoni@enginsoft.com

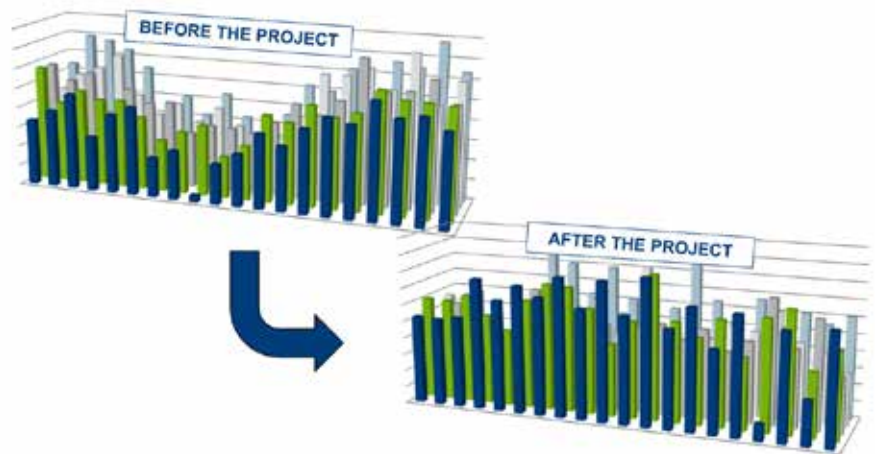

Fig. 2 – 3D histogram of the plant biomass of the 100 plants cultivated, before and after the project.

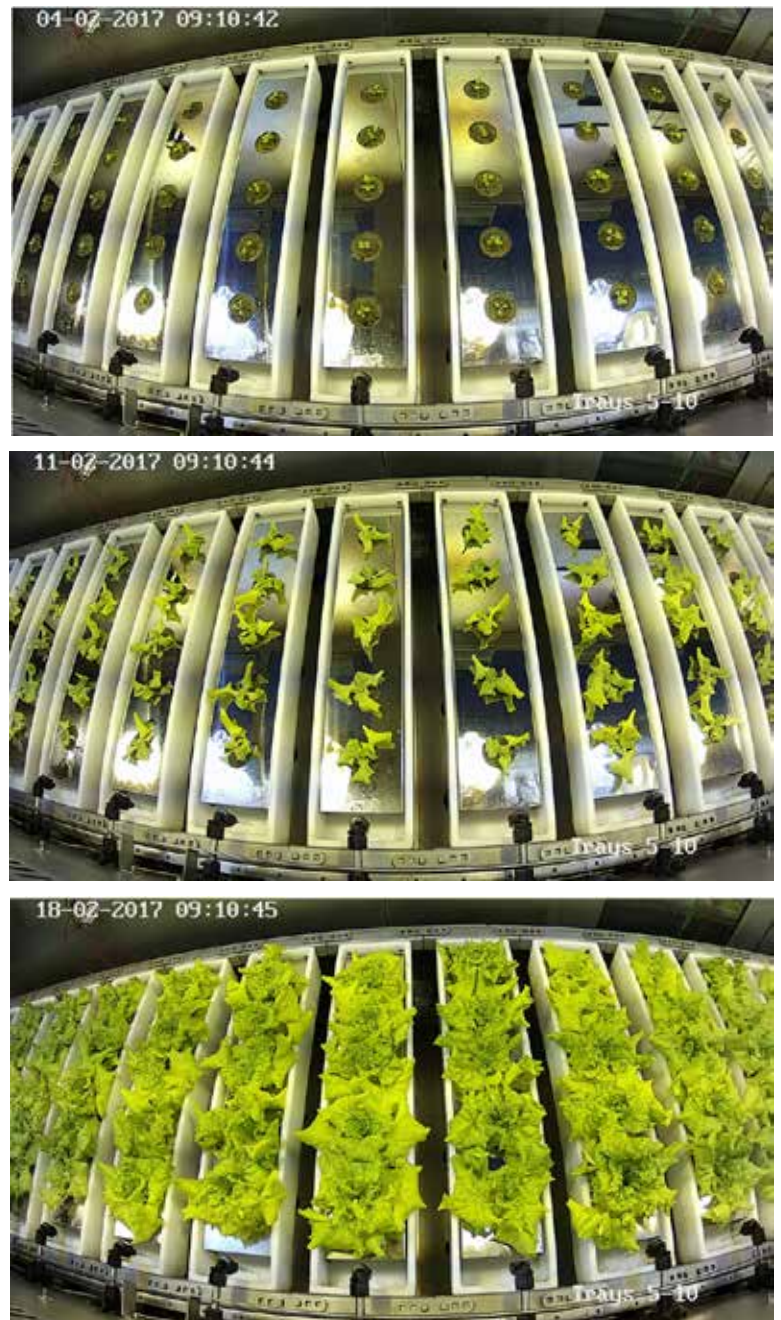

Fig. 3 – Evolution of plant growth process, as captured by one of the cameras installed.



ANSYS 19.0: Cybernet Multiscale Analysis System (CMAS)



New tool facilitates materials testing and microscopic analysis of composite materials

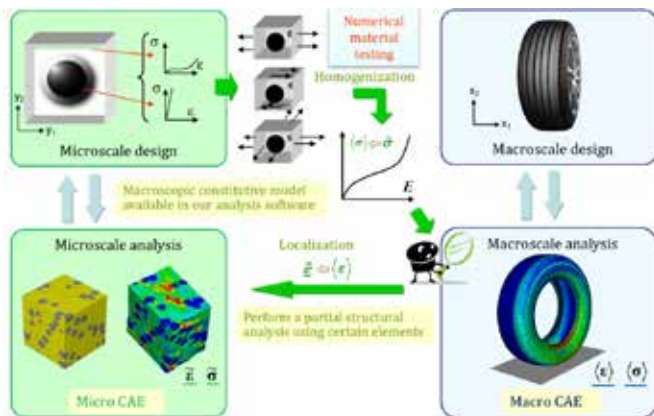

Fig. 1 - Cybernet Multiscale Analysis System features overview

problems. Using this technique, all material constants can be evaluated without expensive experimental campaigns. Cybernet Systems Co. has developed a multiscale analysis CAE tool called the “Cybernet Multiscale Analysis System” (CMAS). Cybernet Systems’ CMAS has been embedded in the ANSYS Workbench GUI using the ANSYS Customization Toolkit (ACT) techniques, making it very easy to use and allowing it to offer leading high-performance productivity for ANSYS Workbench users. The CMAS tool can help engineers to resolve challenges around material modeling and multiple failure modes in composite materials. Using the two functions of homogenization and localization analyses (Figure 1) makes it possible to perform a multiscale analysis of the inhomogeneous material microstructure of a composite material, such as fiber-reinforced plastic or metal, honeycomb, filler dispersion, lattice structures, and so on.

Composite materials are used in many engineering fields but can often cause difficulties for CAE engineers: in particular, Finite Element Analysis (FEM) analysis of composite materials can be quite difficult due to the anisotropic behavior of the materials.

Sometimes, it is also difficult to define all the material constants because composites present three unique challenges:

- Material modeling: Composite materials are composed of innumerable combinations of materials, making it very difficult to build a materials’ database, for instance, for metals;
- Dependence on the molding process: The properties of composite materials are also strongly dependent on the molding process;
- Multiple failure modes: Fracture and damage behavior cannot be simulated easily due to the various fracture mechanisms.

The multiscale analysis technique is designed to overcome these

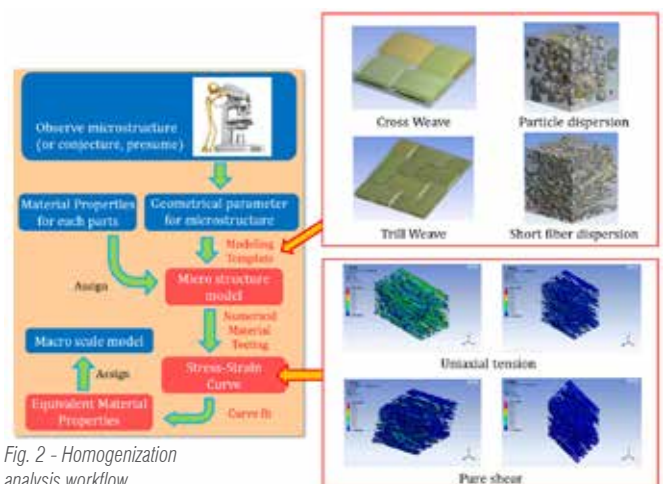

Fig. 2 - Homogenization analysis workflow

**CAE as a materials test device:
Homogenization analysis**

Homogenization analysis can be used to acquire information to predict the physical property values of inhomogeneous materials. The flow of homogenization analysis is shown in Figure 2. Here, the inhomogeneous microstructure of a composite material is modeled to create a micro structure model. CMAS provides some modeling templates to easily create micro-scale models for typical structures of composites (in addition, the creation of custom micro-scale models is made easy by following simple guidelines and recommendations). As a next step, it is possible to acquire the apparent macroscopic material response for any deformation mode (such as the stress-strain curve) by implementing virtual tests for the modeled material. CMAS supports not only the linear properties, but also the non-linear properties such as elasto-plastic, creep, visco-elastic and hyper-elastic.

CAE as a microscope: Localization analysis

Using the homogenization technique, it is possible to acquire the material constants for fractures in composite materials after which it is possible to estimate the existence and occurrence of fractures in the actual structure, and also to determine the fractured region using various general-purpose CAE tools available in ANSYS. However, in the analysis of a model in which an originally inhomogeneous material is

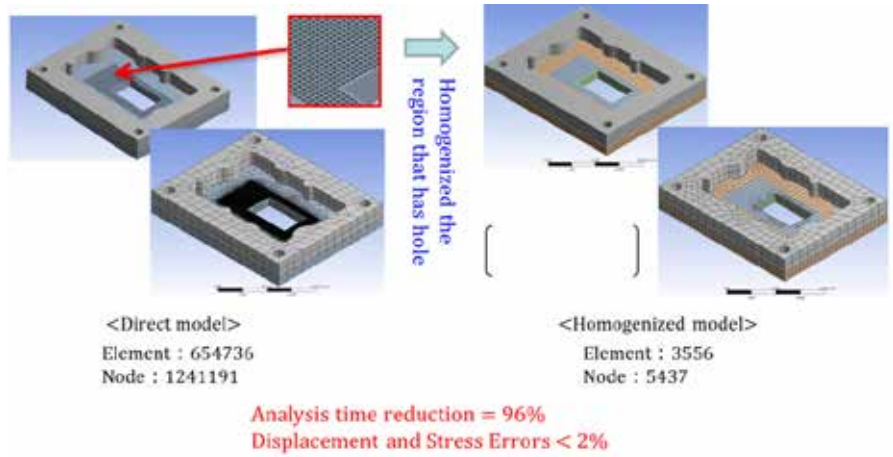

Fig. 4 - Example of a model reduction with homogenization technique

Model reduction

Homogenization analysis can also be used to simplify complex FEM models. Figure 4 provides an example of this. If we look at the perforated plate, we can see that the holes are arranged periodically. Filling these holes with the same material constants as for the parts is not recommended because it leads to an overestimation of the stiffness. The right-hand side of Figure 4 shows the homogenization model which has equivalent materials constants evaluated by homogenization analysis. Instead, the plate can be simplified and the time to complete the analysis can be significantly reduced while maintaining the accuracy of the analysis.

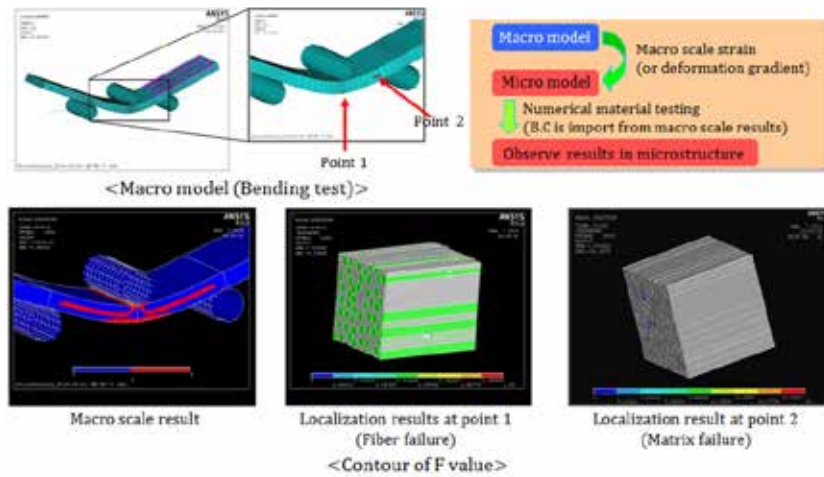

Fig. 3 - Localization analysis workflow and results

substituted by a homogeneous material, it is not possible to estimate the specific factors of the fracture. This problem can be overcome by using CMAS's localization analysis function. A simple analysis example will make it possible to understand this localization analysis function: Figure 3 shows the implementation of a three-point bending test for a composite material. The specimen consists of a unidirectional reinforced material with fibers oriented longitudinally for which the fracture strength is acquired using homogenization analysis. Using the localization analysis, a portion of the homogenized analysis model can be zoomed into (point 1 and point 2) and the resulting microstructure can be evaluated.

For more details on the CMAS software:
Alessandro Mellone - EnginSoft
a.mellone@enginsoft.com

Conclusions

The two main functions of the multiscale analysis tool CMAS, which is embedded in ANSYS Workbench, have been briefly illustrated. The first, homogenization analysis, can evaluate the macroscopic material behavior for any deformation mode, and the material constants for inhomogeneous materials such as composites, lattice structures and so on; the second, localization analysis, enables the user to view the microstructure of any results distribution for inhomogeneous materials.

The features of CMAS will be demonstrated at Cybernet's Materials Modelling Session presentation, and at Cybernet's booth, at the 2018 International CAE Conference.

CYBERNET SYSTEMS is Sponsor of the International CAE Conference 2018
www.caeconference.com

ANSYS CFD Release 19.2 expands user capabilities for product design



New simplified meshing workflow makes CFD simulations faster

The latest release of ANSYS CFD, Release 19.2 continues to expand the user's capabilities for product design with a more comprehensive, easy approach. This article describes some highlights of the new features, with an emphasis on the new, simplified meshing workflow in Fluent that lets you create high-quality meshes, even for complex geometries, with minimal training and effort, speeding up Computational Fluid Dynamics (CFD) simulations and helping engineers achieve accurate results.



ANSYS FLUENT

The new capabilities and overall improvements at different levels in the new release are described below.

Productivity

The first, and most important, step in creating a high-fidelity simulation is the creation of a high-quality mesh, which is usually a time-consuming, hands-on process. Fluent 19.2 introduces a new highly-automated, task-based, meshing workflow for Watertight CAD geometry. This is a guided workflow based on meaningful tasks that steps the user through the definition of simple inputs and choices. Its graphical illustration of the task status minimizes user intervention in the creation of a high-quality mesh. A new meshing method, based on ANSYS's unique Mosaic™ technology, is available in the new workflow. This new Poly-Hexcore meshing method combines a hexahedral bulk volume fill with polyhedral prism and transition cells at the boundaries. This new technology reduces cell-count by up to 50% compared to conventional Hexcore, offers higher cell-quality than all-poly or Hexcore meshes, consumes less memory than all-poly, and offers higher solver performance.

| Conventional Hexcore with Individual Elements | Poly-Hexcore with Mosaic Technology |
|-----------------------------------------------|--------------------------------------------|
| 4.9 million prism elements | 0.3 million poly prism elements |
| 13.8 million cartesian hex elements | 0.3 million cartesian hex elements |
| 13.8 million tetrahedral elements | 0.3 million polyhedral hexahedral elements |
| Total size: 28.2 million elements | Total size: 0.9 million elements |
| | 40 percent size reduction |

The Remote Visualization Client now benefits from a Python console for automating remote runs.

Speed improvements are available for combustion simulations; in particular, Flamelet generation has been refactored using an adaptive grid solution and there is significantly higher speed for serial and parallel computations. The PDF tables reduce memory usage when running on multi-core nodes with shared memory.

Expressions similar to CFX/AIM can now be used in the setup by activating the Beta features which simplify the setup phase with functions of location, time and different solution variables including various physical constants and mathematical functions.

Application Enhancements

In spray-breakup simulations, the Madhabushi Breakup Model can be used for liquid jets in subsonic crossflow. There are improvements for challenging multiphase cases such as the introduction of better convergence in general through new Body-Force Weighted Pressure Discretization, in particular for mixing tanks and problems with large body forces. When using Chemkin-CFD solver, the Chemkin-based properties are used by default for better consistency with the Chemkin mechanism. Some enhancements have also been introduced for the Multi-Scale Multi-Domain (MSMD) Battery model for better parameter estimation in Equivalent Circuit Models (ECMs).

Solver/Numerics

An optimized numerical treatment is available for the non-conformal interfaces frequently used in Conjugate Heat Transfer and Moving Mesh problems. Improvements in Hybrid Initialization provide better initial conditions for incompressible and multiphase flows and eliminate non-physical wiggles.

For more information, contact:
Michele Andreoli, EnginSoft
m.andreoli@enginsoft.com

ANSYS CFX

ANSYS CFX 19.2 extends the features for turbomachinery CFD simulations.

Turbo Tools

A new axial element mode for blade construction is available in BladeEditor that ensures a constant axial profile from hub to shroud. In TurboGrid, a conformal tip gap mesh can be generated using

Application Enhancements

The new release introduces a new mechanism for modelling an array of flow injections or bleeds into and out of the domain using mass sources and sinks. The user does not need to mesh and resolve holes, but the injection is modelled as a virtual boundary condition that can move with the mesh. Different applications e.g. sprinklers, blade cooling, and shower heads can benefit from this new methodology.

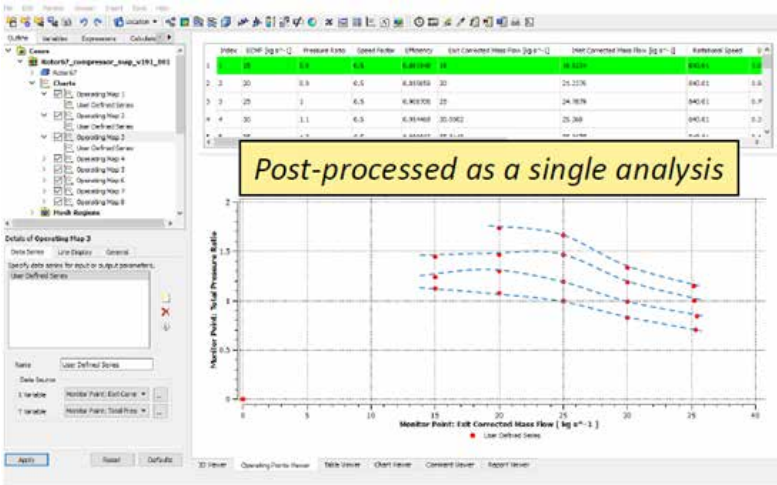
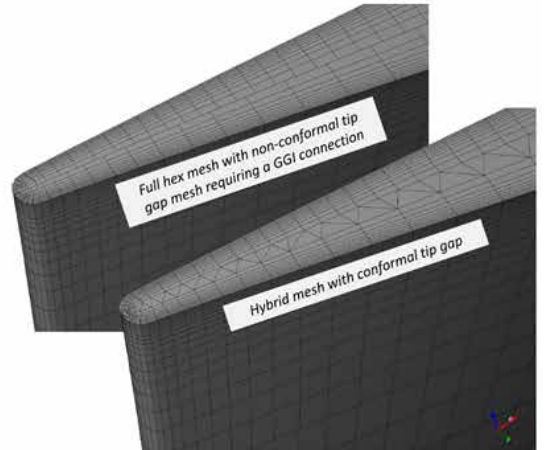
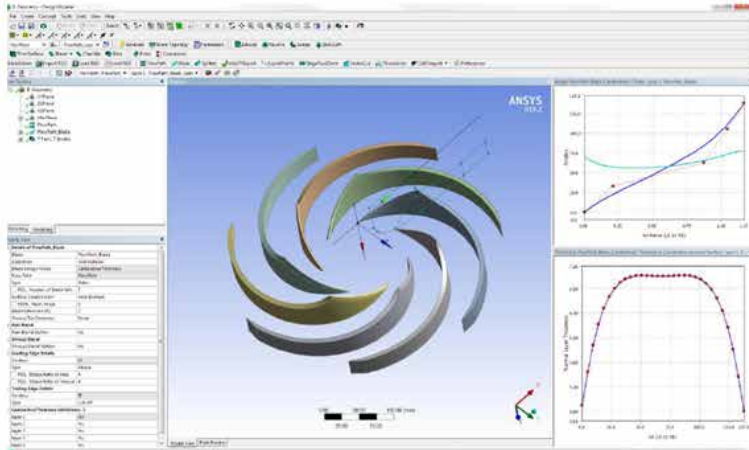

Post-processed as a single analysis

Harmonic Analysis has been enriched by the addition of the Fourier-Transformation (FT) Transient Rotor-Stator (TRS) methodology. The Fourier Transformation pitch-change method does not have any limitation on the pitch ratio (or nodal diameter for a blade flutter application) and works with both compressible and incompressible flows.

Modelling single-stage rotor-stator interaction using a phase-shifted periodic boundary from FT with the Harmonic Balance method, provides the user with faster solutions to calculations of transient periodic flows.

tetrahedral elements to provide a more robust option for blade flutter and Fluid Structure Interaction (FSI) calculations with moving blades.

Productivity

The operating maps make it easy to extend an analysis from a single operating point to a full operating range and are applicable to any CFD analysis. The workflow is managed as a single run which generates multiple solutions, the results are collected in a run folder and are post-processed as a single analysis while the input parameters for the operating conditions are managed via tables.

For more information, contact:
Alessandro Arcidiacono - EnginSoft
a.arcidiacono@enginsoft.com

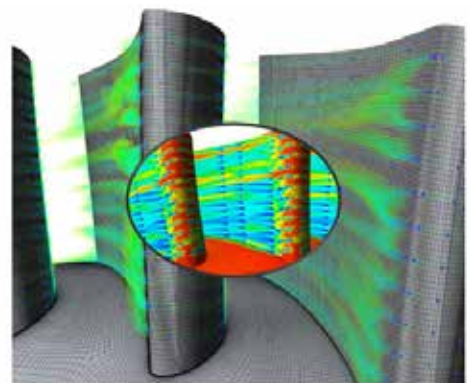
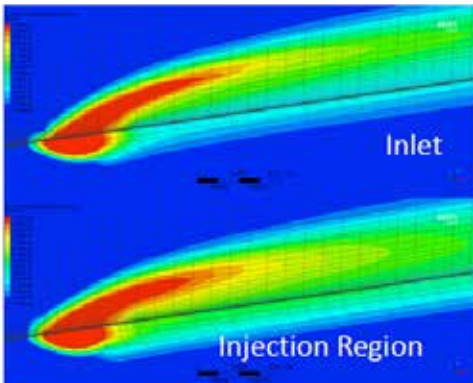

ANSYS Chemkin Enterprise: all the tools for reaction flow simulations in a single license

Simulations of reacting flows are critical to developing competitive products in several industrial sectors, such as transportation, energy generation, materials processing, the chemical industry, and many others. Improving the designs in these cases is difficult because they often consist of systems with complex geometries, boundary conditions and physics, such as large networks of chemically reacting species, turbulence and radiation. ANSYS Chemkin Enterprise couples multiphysics simulations incorporating advanced physical models with an advanced chemistry solver to provide complete simulation capability for reacting flows. ANSYS Chemkin Enterprise includes ANSYS Chemkin-Pro, ANSYS Forte and ANSYS Model Fuel Library (figure 1).

ANSYS Chemkin-Pro

ANSYS Chemkin-Pro is a standard for solving the complex chemical kinetics problems and surface chemistry reactions that are used for the conceptual development of combustion systems. Chemkin-Pro has evolved from its origin as a Sandia National Laboratory combustion kinetics code (Chemkin II); it has been extensively validated over several decades and frequently cited in technical peer-reviewed journals. Engineers can quickly explore the impact of design variables on performance, pollutant emissions and flame extinction using large, accurate Equivalent Reactor Networks (ERNs, figure 2) which allow the simulation of real-world combustors, burners and chemical reactors and enable the most efficient prediction of emissions using detailed chemistry. Chemkin-Pro is specifically designed for large chemical kinetics simulations requiring complex reaction mechanisms. It also provides automated mechanism-reduction capabilities (using the Reaction Workbench add-on).

ANSYS Forte

ANSYS Forte robustly and accurately simulates the combustion performance of Internal Combustion engines with almost any fuel, helping

engineers to rapidly design cleaner-burning, high-efficiency, fuel-flexible engines. It incorporates proven ANSYS Chemkin-Pro solver technology. Forte uses multi-component fuel models combined with comprehensive spray dynamics, without sacrificing simulation time-to-solution. It also includes different advanced technology to reduce the computational costs of a simulation:

- Automatic mesh generation including solution adaptive mesh refinement and geometry-based adaptive mesh refinement.
- True multi-component fuel-vaporization models.

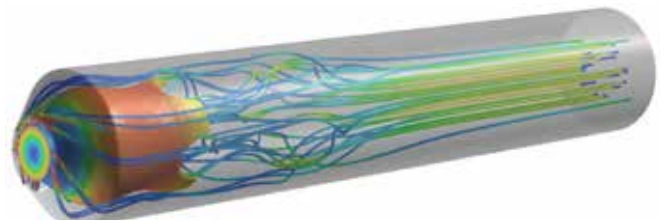

Fig. 3 - Can-type Gas Turbine Combustor

- Advanced spray models to reduce grid and time-step dependency when compared to existing approaches.

ANSYS Model Fuel Library

If a more complex 3D Computational Fluid Dynamics (CFD) combustion model is required (figure 3), ANSYS Model Fuel Library provides a database for ANSYS CFD solver (FLUENT/CFX) with accurate, detailed chemical mechanisms for over 65 fuel components, representing every class of reaction that is important for combustion simulations. Chemkin generates gas kinetics mechanisms for other computational software packages, such as ANSYS' FLUENT CFD software, to add accuracy, speed and stability to calculations using finite-rate, multi-step reaction kinetics (figure 4). In this way, Chemkin provides more accurate numerical methods, allowing users to incorporate more detailed kinetics descriptions into their CFD simulations in ANSYS' FLUENT.

For more information:
Fabio Villa - EnginSoft
f.villa@enginsoft.com

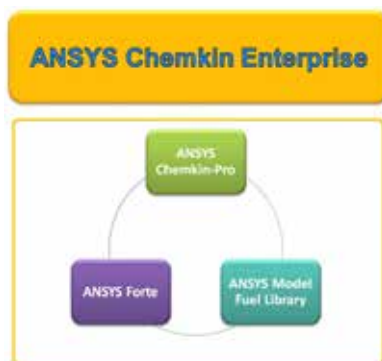

Fig. 1 - ANSYS Chemkin Enterprise

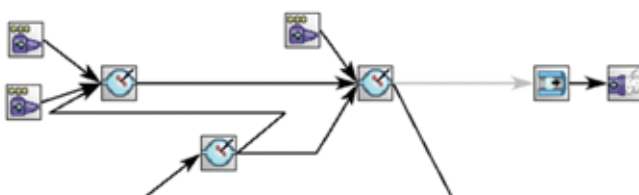

Fig. 2 - Equivalent Reactor Networks

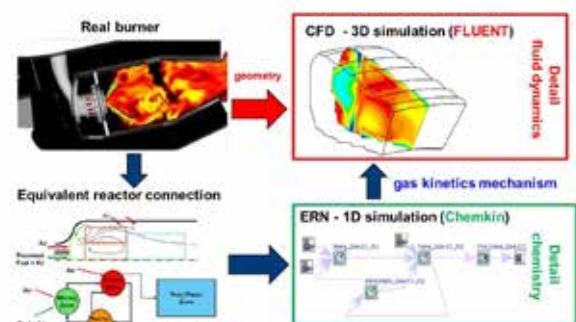

Fig. 4 - Burner simulation for link-detailed combustion chemistry and CFD

Using a 1D-3D co-simulation of a hydraulic pump failure to measure the pressure surge in a 2km pipeline



Hydraulic systems, from the smallest to the largest, operate in many different situations and under many, often extreme conditions. They can also undergo various operational and emergency procedures, such as the pump tripping or valve closure, that may cause severe pressure surges. The so-called “water hammer effect”, which can damage a system and cause serious safety issues, is a frequent problem affecting hydraulic systems.

Since it is not possible to test most of these systems before their installation, it is very important to create the most reliable design possible in the early phase of a project. One solution is to create a virtual system model that includes the Piping and Instrumentation Diagram or the Process Flow Diagram of the pipeline.

Flownex can be used to model both simple and complex hydraulic networks, and to simulate and predict critical scenarios such as the pump

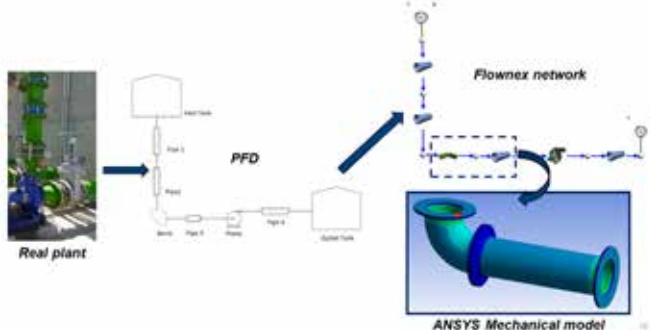

tripping or valve closure. Generally speaking, Flownex is a Computational Fluid Dynamics (CFD) system simulation software that solves equations for conservation of mass, energy, linear and angular momentum. Its fundamental approach is based on a thermal-fluid network of 1D flow components, together with two-dimensional rotating components, and heat transfer building blocks. The solution is calculated with an implicit and fast steady-state and dynamic solver.

In this example, a 2-km water pipeline was modeled in Flownex. The modelled pump moves the fluid flow by rotating at 1450 rpm with a rated mass flow of 140 kg/s. The scenario simulated a sudden critical event that causes the pump to trip and fail. Flownex dynamic transient solver is able to simulate the pressure wave that would be produced by such an event,

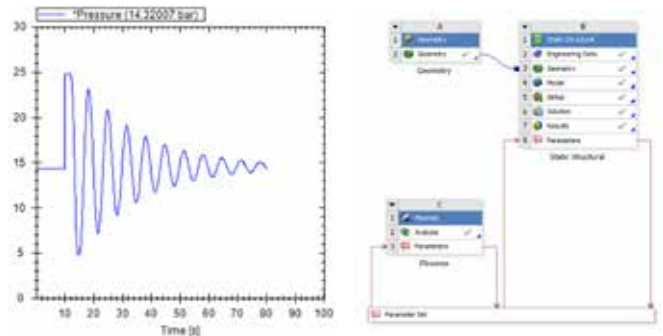

providing the user with the resulting pressure distribution all along the 2-km discretized pipe, at every time-step simulated.

The software is very easily coupled with ANSYS 3D models for instant co-simulation results, such as the total deformation in the pipe bend due to the pressure wave. In a 1D-3D coupling, the 1D system’s accuracy in modelling complex and critical elements is greatly increased by the detailed three-dimensional model. Similarly, the 3D simulation can take advantage of the boundary conditions provided by the 1D simulation. Combining large but fast-solving 1D networks with accurate 3D models can create very high fidelity simulations, for both steady and transient states.

In this case study, the Flownex network was embedded in the ANSYS Workbench environment. The WB Parameter Set enabled the output pressure data from the water hammer simulation to be passed to the Static and/or Transient structural models of the pipe.

ANSYS Mechanical calculated the deformation and the Von Mises stress in the model of the local critical part of the pipeline, in this example a bend, allowing the user to understand if the intensity, duration and frequency of the pressure wave could be dangerous for the pipe’s integrity.

The simulation time required for this kind of 1D-3D coupling naturally depends on the type of mechanical model, and ranges from a few tens of seconds for a coupling with the Static Structural model, to a few minutes for a coupling with the Transient Structural model.

For more information:
Alessandro Arcidiacono - EnginSoft
a.arcidiacono@enginsoft.com

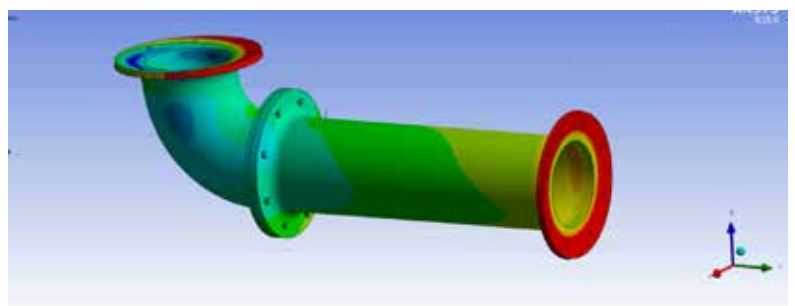

Improved Fatigue Prediction for Rotating Components

New method provides more precise analysis of damage, faster for all types of rotating components

FEMFAT software

In contrast to components in which the forces and moments can be expected and applied at fixed locations (e.g. simple attachment parts, chassis, car bodies, etc.), the situation is somewhat more complex with rotating components.

In the steady-state case, unit loads are typically calculated at the points where forces are applied, and scaling is accomplished using measurement data, for example. Subsequent superpositioning then yields to the complete stress-time history for the component. The fatigue life of the overall component can be determined in combination with material data and appropriate fatigue analysis methods (see Figure 1).

Instead, the rolling simulation of rotating components is typically not performed using a transient simulation with real load-time data because it would be too elaborate and cost intensive to calculate with current engineering practices.

However, the rotation involved here does require additional effort to determine the application of forces. One approach is to attempt to create a steady-state, non-rotating case for these components. The rotation is created by altering the application of the point of force to determine the stress history as it changes over time for the component (see Figure 2).

In a case like this, not only is the load itself a function of time, but so is the position at which it is applied. This must be tediously determined manually, and additional tools are required. Consequently, the complex loading of these components is usually simulated using very simple loads (e.g. a constant moment) to ensure a safe design.

Instead, the new approach shown in this article helps to enable a more realistic determination of the damage by taking local and global influences into account. This method has a broad range of applications. It can be used for all components which are subjected to rotating loads, such as

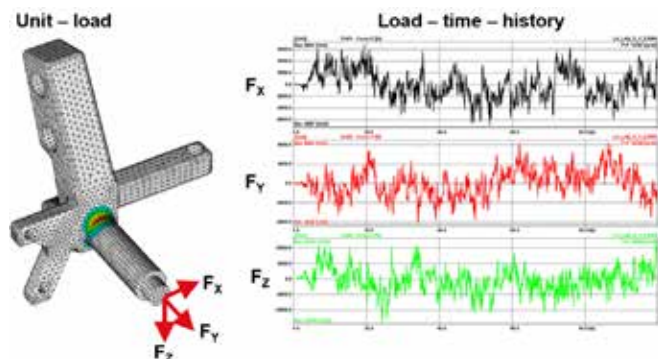

Fig. 1 - Load definition for a multiaxial fatigue analysis

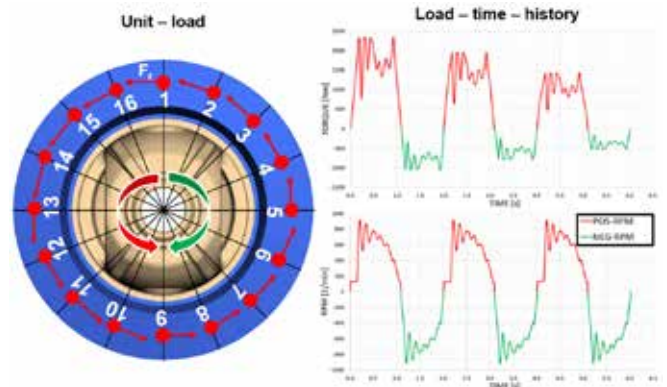

Fig. 2 - Load definition for a multiaxial fatigue analysis of rotating components

wheel carriers, clutches, drive shafts, transmissions, differential cages, rims, and many more.

Improved damage analysis using the example of a differential cage

The model used is shown in Figure 3. All the relevant parts of the differential cage were modelled with approximated stiffness. The bearings were modelled with non-linear spring characteristics to represent the tension-pressure asymmetry. All the relevant contact points were modelled with friction. The overall system was fixed to the outer bearing rings. Force was applied to the ring gear. The pitch of the force application was defined at 16 positions every 22.5° (see Figure 2).

The non-linear analysis was carried out for a forwards and backwards moment of 1000 Nm.

In the first step of the analysis, the M10 screws were pre-tensioned with a force of 50.6 kN. This state was fixed and then the three analytically-calculated tooth contact forces were applied to the 16 individual load cases. Upon completion of the calculation, a total of 32 stress states were available for the fatigue analysis (16 forwards and 16 backwards). These stress states became the basis for the subsequent fatigue analysis.

Transformation of the torque history into a unit matrix based on real measurement data

Based on the existing simple analyses, more complex loads could now be analyzed for damage. The objective was to calculate the damage of a real torque and speed history (see Figure 2).

Consequently, the following input was required to generate the load:

- 1) Torque-time history
- 2) Speed-time history
- 3) Pitch of the force application on the Finite Element (FE) model

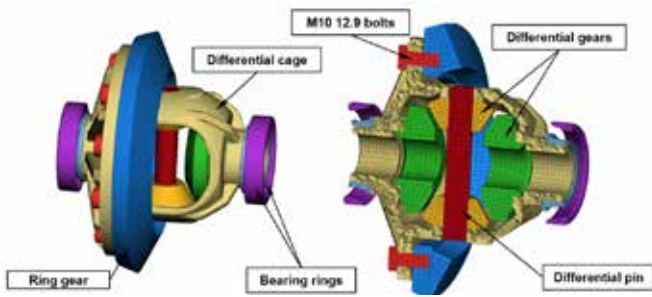

Fig. 3 - FE model of a differential cage

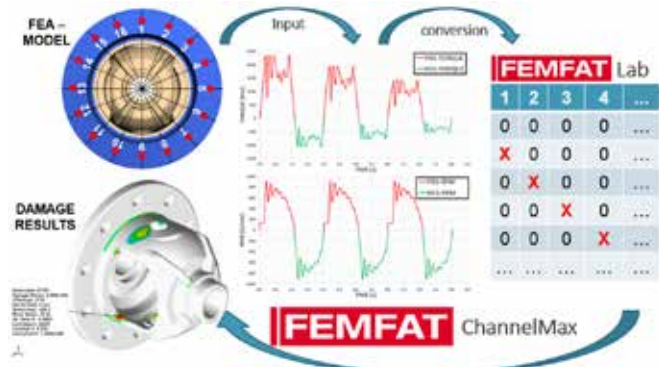

Fig. 4 - Overall process for the analysis of complex load-time signals

The output was a load-time history, in the form of a matrix, in which a scale-factor of the unit moment was generated for each position (1-16) at specific points in time. The overall process is shown in Figure 4.

Necessary steps for the generation of the input data:

- 1) Division of the torque-time history into positive and negative torque components. While this step is not absolutely necessary, it does increase the accuracy of the analysis by linearizing the contacts at the working point.
- 2) Normalization of both components using the unit moment from the Finite Element Analysis (FEA). In this case, the torque histories were scaled by a factor of 1/1000.
- 3) Because the direction (sign of the moment) of the backwards rotation was already included in the FEA, the neg. moment component was multiplied by -1.

The newly-created excitations (see Figure 5) provided the input for the FEMFAT LAB software, in combination with the torque-time history and the specification of the pitch.

The software then created the necessary matrices for the correct depiction of the scale factors for each position on the differential cage at the correct point in time, T_x . It must be mentioned that this method represents an approximate solution in certain areas because non-linear effects are taken into account by means of a working point. In our case, however, this has zero or a negligible effect on the fatigue analysis result. It is possible to minimize this error, however, for example by multiple subdivision of the load-time signal into several unit-moment levels (500, 1000, 1500, ...).

With the process shown in Figure 4, it is now possible to analyse any type of measurement signal for its safety factor or for damage. The measurement signals need no processing and can be used directly for the damage analysis. This allows real

measurement signals with several million sampling points to be used for the fatigue analysis. This is reflected in the duration of the calculation, of course. However, parallelization allows the calculation to be accelerated. Figure 6 shows the result of the fatigue life analysis.

Summary and outlook

This new and more precise method for damage analysis of rotating components represents a considerable improvement over the standard methods currently in use.

The very accurate analysis of the local damage can be used to create new test bench loads, for example. This method is fast, delivers more accurate local damage information and can be employed for all types of rotating components.

The ongoing development process will focus on making it even more accurate. Moreover, the degree of automation of the method will also be increased to reduce the overall turnaround time required for the process shown.

W. Hübsch and H. Dannbauer,
Engineering Center Steyr GmbH & Co KG

For more details on the FEMFAT software:

Dario D'Agostino - EnginSoft
d.dagostino@enginsoft.com

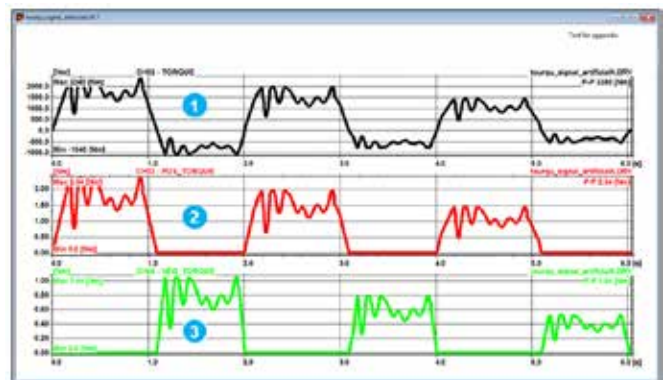

Fig. 5 - 1 Original torque, 2 Pos. component scaled 1/1000, 3 Neg. component scaled -1/1000

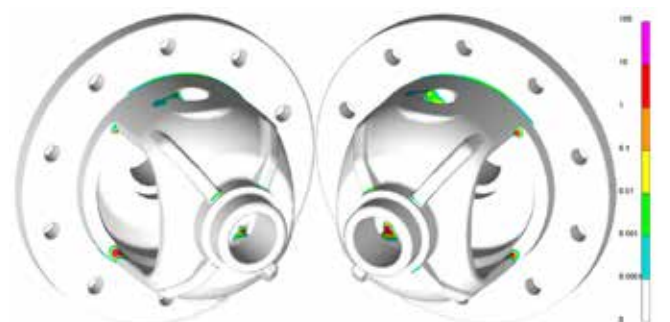

Fig. 6 - Normalized reference damage in [%]

FEMFAT is Sponsor of the
International CAE Conference 2018

www.caeconference.com

CAESES: CAD for Automated Design Studies with Simulation Tools



For simulation engineers who need to improve and optimize the fluid flow or thermal performance, of their products or address structural issues, CAESES offers efficient CAD and process integration to automate simulations that optimize product shapes. As a result, engineers can run large design studies overnight or over the weekend with hundreds or even thousands of design variants, to ultimately pick the optimal design, which, for example, shows the best aerodynamic behavior, or



Fig. 3 - Parametric turbocharger turbine including parametric flow and structural domain for automated meshing



Fig. 1 - CAESES comes with specialized CAD, CFD automation, and an integrated optimization environment

the greatest robustness. Unlike traditional CAD tools, the geometry generation in CAESES can be fully automated and does not break, or fail to regenerate, during variation. Hence, CAESES is best-suited to large automated design studies that are run on powerful workstations or High-Performance Computing (HPC) clusters.

APPLICATIONS

CAESES is most commonly used whenever flow-exposed products need to be optimized in an automated way. It is integrated into

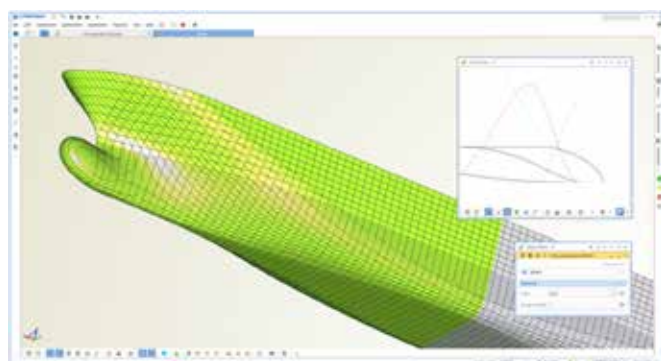

Fig. 2 - Parametric ship hull-form model in CAESES, variable and ready for shape optimization

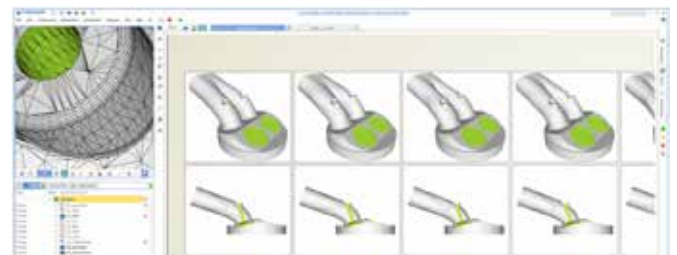

Fig. 4 - Geometry modeling and automated variant creation of an intake port in CAESES

the design processes at leading companies worldwide, such as SIEMENS, Samsung, VW, Toyota, Rolls-Royce, Ebara, Caterpillar, Suzlon and VOITH. Another large customer base is in the marine industry where the Computational Fluid Dynamics (CFD)-driven optimization of ship hull-forms and propellers are key engineering tasks. For instance, CAESES is used to design and optimize large container vessels where an optimized hull-form can save more than \$ 1-million of fuel costs – per year!

CAESES is also routinely used in the turbomachinery sector for the design of turbines, compressors, pumps, fans, and volutes. It has a dedicated turbo module, which allows users to design highly customized, 3D blades using, for example, meridional contours as well as camber- and thickness-based profile descriptions. These blade models are simulation-ready and optionally include the parametric fluid and solid domains for automated meshing.

Being able to define, control and optimize each detail of the blade is a major benefit compared to the use of standard black-box tools. The high customization and programming capabilities of CAESES provide users with a platform to incorporate all their expertise and innovative ideas, no matter which application is considered.

In the automotive industry, CAESES helps engineers to design and optimize the shape of critical components such as piston bowls, manifolds, intake ports, ducts and wings. These geometric models

Fig. 5 - Shear head geometry for polymer injection applications, robust and variable for automated studies

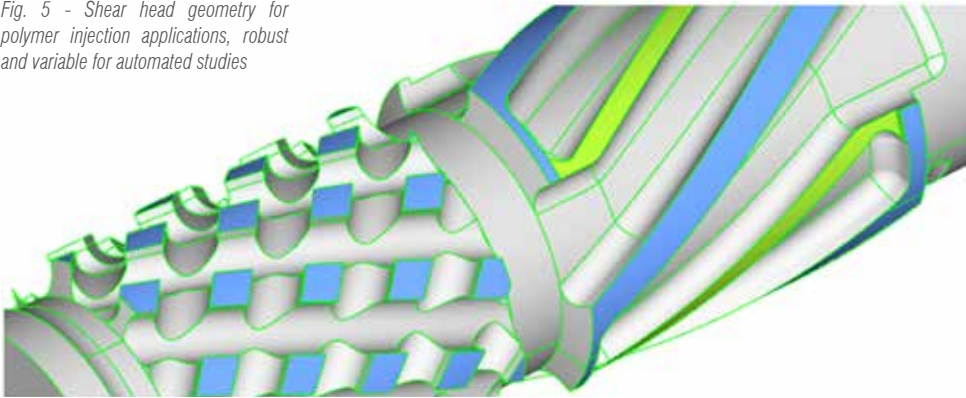

are then also set up for automated processes and can incorporate geometric constraints such as space limitations, cross-sectional areas and target volumes. As a result, only feasible designs are created during the optimization process, which drastically reduces the overall computation time.

CAESES is also used in the medical sector for the design of blood pumps, and in process engineering to vary and optimize sophisticated free-form shapes (e.g. a shear head for polymer injection).

GEOMETRY MODELING

Traditional design and production CAD packages, although powerful, are rather detail-oriented and encompass features that are not relevant for simulation. CAESES can be considered a complementary tool in the pre-CAD stage, to optimize a product's

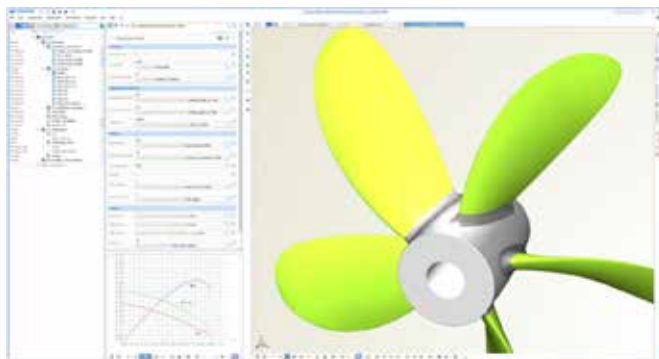

Fig. 6 - Meta surfaces allow CAESES users to generate advanced 3D sweep surfaces based on function graphs

performance using geometry models that are useful for simulation engineers. It focuses on complex surfaces that are difficult to parameterize with other tools and where the generation of an automated geometry is challenging and needs to be 100% robust. CAESES includes specialized modeling approaches for smarter surface design, such as the proprietary Meta surface technology, which allows users to create advanced sweep surfaces based on parametric 2D profiles. These surfaces can be controlled in the 3D space through user-defined function graphs. This intuitive and efficient technique can massively reduce the number of design parameters and at the same time generates extremely smooth shapes.

For rapid design studies of existing CAD geometries, users can import their data and apply shape changes

such as free-form deformations and Radial Basis Functions (RBF) morphing.

OPTIMIZATION

Besides geometry modeling, CAESES comes with integrated capabilities for the automation of Computer-Aided Engineering (CAE) tools and with advanced optimization strategies. The user can create design variables with lower and upper bounds for all geometry

and analysis parameters. These variables can then be accessed by the different integrated optimization strategies, such as sampling methods, genetic algorithms and efficient response surface techniques.

External third-party optimization tools can also be used to control and change the values of the design variables, as an alternative to CAESES' integrated optimization strategies. For this purpose, CAESES offers an easy-to-use batch mode option to enable it to be integrated into any workflow as a background CAD engine. For batch mode use on cluster systems, CAESES is also available in a Linux version.

THE COMPANY BEHIND CAESES

CAESES is developed by the German company, FRIENDSHIP SYSTEMS AG. With more than 15 years of expertise in parametric modeling and optimization, FRIENDSHIP SYSTEMS is one of the leading suppliers for parametric, simulation-driven shape optimization in the CAE industry.

For more information, visit:
www.CAESES.com

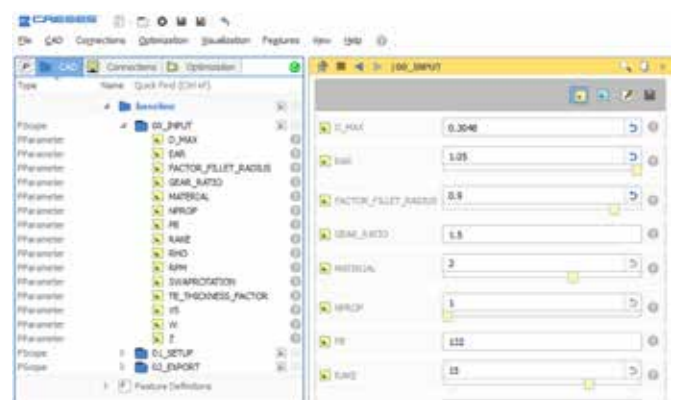

Fig. 7 - Design variables of a CAESES model with lower and upper bounds that can be changed manually or automatically

**Friendship Systems is Sponsor of the
International CAE Conference 2018**

www.caeconference.com

CAE Software Reinvented for the Cloud

Faster time-to-results at lower cost



With cloud usage growing rapidly among both large enterprises and SMEs, it will be just a matter of a few years before we see the majority of engineering companies shifting from using traditional, on-premises CAE software to cloud-based solutions. "This is a trend that we have noticed at SimScale from the constantly growing number of new customers that range from large companies such as Aqseptence Group, Thornton Tomasetti or Cooper-Standard Automotive, to SMEs such as Spark, SYSTAG System Technik or VTOL Technologies, all of whom have adopted SimScale's solution for their simulation needs," says David Heiny, CEO and co-founder of SimScale.

Companies of all sizes view cloud technologies as an opportunity to conduct their operations in a more efficient and cost-effective way, which is especially important within today's design environments where the demand for faster development and better results at lower cost is increasing.

SimScale has embraced the value of the cloud from the moment the company was founded. "Since its official launch in 2013, SimScale

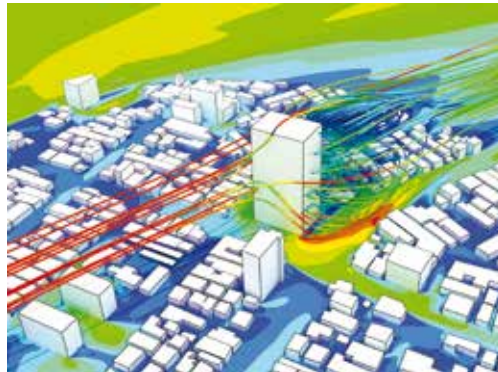

customers to save an average of €30,000 in expensive hardware costs and software maintenance fees. The customers only need an Internet connection to run demanding simulations on a laptop or any device of their choice. At the same time, SimScale also significantly reduces the time-to-result by providing the option to test multiple design versions in parallel. Even for large or complex designs, the access to up to 96 cores and real-time simulation allows customers to get their results faster than was ever possible

before with any traditional simulation tools," says Heiny. Another important benefit of the "zero hardware and software footprint" approach is seamless collaboration. With SimScale, globally distributed design and engineering teams can easily share and collaborate on their projects in real time. This is especially important given that 40% of companies with 50 to 249 staff members have employees who regularly work outside the office and need access to data and applications via the cloud. Moreover, whenever one of these employees encounters any issue with the simulation setup, he or she can quickly get guidance from one of SimScale's engineers via the chat option available directly from the platform.

With all SimScale's above-mentioned benefits being enabled through the cloud, it is no longer a question of "if" but "when" the major shift from on-premises CAE solutions to cloud-based solutions will happen. The international research group Gartner says that by 2020, a no-cloud policy will be as rare as a no-Internet policy is today. It is believed that even the companies that currently have a no-cloud policy use some form of internal cloud services. In the coming decade, the associated costs will become untenable, and the use of hybrid approaches will become increasingly common. Industry experts further predict that most software services will start moving to being cloud-only and that the use of Software as a Service (SaaS), Platform as a Service (PaaS), and Infrastructure as a Service (IaaS) will increase exponentially.

"It is safe to say that the future of CAE technology is the cloud, and SimScale has taken the lead in delivering this sooner than could have initially been expected," states Heiny.

Try SimScale for free and start simulating in minutes at the link: <https://www.simscale.com/product/pricing/>

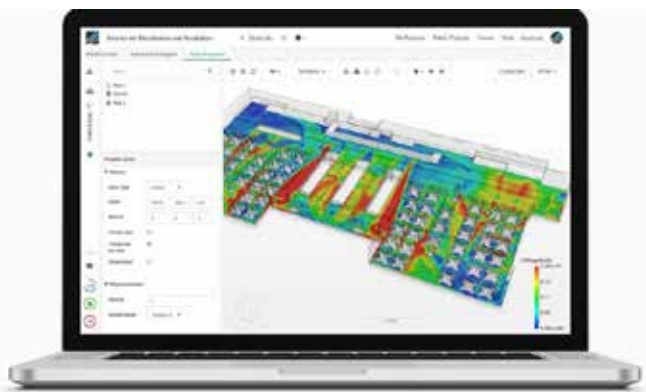

has been challenging the "status quo" of the traditional computer-aided engineering (CAE) software market by offering a fully cloud-based engineering simulation solution for Computational Fluid Dynamics (CFD) and Finite Element Analysis (FEA), with zero hardware and software footprint, available at a fraction of the price of its competitors," explains Heiny.

Today, SimScale is an integral part of the design validation process for thousands of successful companies worldwide and over 120,000 individual users. It is mainly used by product designers and engineers across the AEC (Architecture, Engineering & Construction), HVAC (Heating, Ventilation & Air-Conditioning), Electronics and Automotive industries. "By leveraging the power of the cloud, SimScale helps

**SIMSCALE is Sponsor of the
International CAE Conference 2018**

www.caeconference.com

PASS/INSULATION and PASS/RELIEF to join PASS Suite

PASS Suite capabilities extended with proven, efficient modules for the sizing and analysis of insulation material and pressure relief systems



Two new modules will soon be added to the PASS Suite and will be available to interested customers in the coming months for beta testing.

PASS/INSULATION is a powerful solution for piping and equipment thermal insulation analysis, sizing and design. It is especially effective for the insulation design of large and complex industrial objects – process plants, pump and compressor stations, as well as storage facilities in the power, oil & gas, refining, petrochemical and chemical industries.

The module can import all insulated objects (usually there will be hundreds or thousands of them) together with their geometrical and technological parameters from 3D models created by leading 3D plant design CAD systems like AVEVA PDMS or Everything3D. The software not only sizes insulation thickness according to different requirements under complex conditions such as underground piping and objects heated with steam or electrical tracing, but also automatically selects all the necessary main and auxiliary materials for the insulation structure. This selection is based on the insulation vendors' data and produces all the necessary reports for cost estimates, materials procurement and construction/installation.

PASS/INSULATION can also create documents to simplify the ordering of

electrical heat tracing systems from manufacturers. In summary, PASS/INSULATION makes insulation designers significantly more efficient, relieving them of time consuming routine work with a dependable, automatic process from sizing to material selection!

The PASS/INSULATION software has already been used for several decades by hundreds of Russian (and other former USSR countries) EPC companies and has thus become an informal standard in this market segment. Now PSRE Co. is making these powerful solutions available to all thermal insulation designers looking for more effective ways to address their workload.

The second upcoming addition to the PASS Suite, PASS/RELIEF, is a pressure relief system sizing and analysis tool. It combines PASS/HYDROSYSTEM's main features of real gas, liquid and gas/liquid flow analysis (for inlet and discharge piping) with pressure relief valve sizing, according to the international and national codes (API 520, ISO 4126, GOST 12.2.085-2017 and JN 4732). For multiphase gas/liquid flow or flow of supercritical fluids and other complex cases, the HDI method (recommended by API 520 and AIChE DIERS) is used.

These two new elements in the PASS Suite will complement the existing PASS modules and significantly extend PASS' smart Simulation & Sizing Tools for every piping and equipment engineer and designer.

PSRE Co. Announces a New Version of PASS/HYDROSYSTEM

New release supports three-phase flows in Oil&Gas pipelines and performs multi-parameter optimization

The new version 4.1 of PSRE Co's PASS/HYDROSYSTEM, scheduled for release just before the 2018 International CAE Conference, contains two big improvements, which are expected to considerably extend the applicability of this versatile solution.

Firstly, users can now analyze three-phase gas/oil/water flows typical of Oil and Gas field piping systems, including the automatic calculation of flow rates for each phase in any part of a complex piping network. To enable this, the software takes into account the mixing of three-phase flows with different phase flow rates. Preserving its renowned ease-of-use, the PASS/HYDROSYSTEM GUI has been extended to provide different convenient options for setting each phase flow rate at source (oil well) nodes.

In this new version, gas/oil/water flow is analyzed as two-phase gas/liquid flow whereby the liquid oil/water emulsion is simulated using the HEM model for density and Brinkman – Roscoe generalization of the Einstein formula for viscosity. The program monitors inversion points and defines which type of emulsion – water in oil or oil in water – takes place in each specific part of the piping network.

Furthermore, the new Tulsa University Fluid Flow Projects (TUFFP) Unified Model Library for three-phase flow will be integrated as soon as this library is ready for use – currently

anticipated during the fourth quarter of 2018 or the first quarter of 2019. The second important improvement allows users to analyze and optimize piping networks containing multiple arbitrary control valves, orifices or other elements with controlled parameters. The parameter selection feature, initially introduced in version 3.88, is now capable of supporting any number of parameters. These unlimited parameters combined with a modern, derivative-free optimization method (by Powell), enables PASS/HYDROSYSTEM users to find optimal combinations of valves and orifices parameters for complex piping networks.

The new version of PASS/HYDROSYSTEM will be demonstrated at the PSRE Co booth during the 2018 International CAE Conference. Users interested in a first look can also attend PSRE Co's related presentations, which form part of the Oil & Gas section of the conference.

PSRE is Sponsor of the
International CAE Conference 2018

www.caeconference.com



Modularization, democratization and standardization: the ESTECO technologies roadmap

Interview with Danilo Di Stefano, modeFRONTIER product manager and Matteo Nicolich, VOLTA product manager



Danilo Di Stefano



Matteo Nicolich

Q: ESTECO has been changing the approach to its technologies over the past few years, positioning itself more and more as a provider of modular solutions. What is the new vision for ESTECO technologies?

A: Danilo Di Stefano, modeFRONTIER product manager: The direction we are taking as a technology provider is reflected in three focus areas: modularization, democratization and standardization. Modularization allows the end user to work in a consistent environment so that they can focus on their task without distractions. To this end, our efforts are also concentrated on the user experience (UX) with the intention of enabling an ever more productive experience for our end users. This philosophy pervades our entire development process, from the code to the commercial aspect, where we provide flexible solutions so that our clients can acquire only those elements of our technology that suit their particular needs.

Matteo Nicolich, VOLTA product manager: Then there is democratization, not intended as technology for dummies, but as technology that offers the best value without requiring the user to become an optimization expert. We want our technology to reach beyond the field experts and extend the benefits to a wider target of engineers. As for standardization, we are constantly increasing the interoperability of our formats, from Functional Mockup-Interface (FMI) files to workflows based on Business Process Model and Notation (BPMN), the leading standard for business process modeling.

Q: The backbone of ESTECO technology has always been state-of-the-art algorithms. ESTECO solutions now come with a set of algorithms that can be started either in manual, self-initializing or autonomous mode. Can you tell us more about this?

A: Di Stefano: We are focusing a lot on perfecting our autonomous modality, now available in all our solutions. This modality is not intended to be a magic solution -- rather it is a way to make the best use both of the time and the expertise of our end users, who often work under strict deadlines. It helps the user find the best compromise between the time at hand and the quality of the solution. Our autonomous piLOPT algorithm is particularly interesting because it guides the user in choosing the best optimization strategy for the problem at hand. Diversely, the manual mode is perfect for the most expert users who have time and need maximum flexibility to obtain the best results.

Q: modeFRONTIER Release 2018 Spring has a new Graphic User Interface. Can you tell us a bit about what has changed?

A: Di Stefano: This year we released modeFRONTIER with an entirely revisited user experience, in terms of both look-and-feel and usability. The new home environment offers quick access to all you need to

start your project, guaranteeing maximum productivity. Moreover, the most important actions in each of the modeFRONTIER environments - Workflow, Run Analysis and Design Space - now each have their own toolbar. From the Tools menu, you can access modules for design space analysis and workflow building, modeSpace and modeProcess, that are available in each modeFRONTIER installation. Of course, the robustness of our numerical solutions and the traditional solid approach to code development continue to be at the core of modeFRONTIER.

Q: Recently, ESTECO's enterprise solution, VOLTA, closed deals with important new clients such as Peugeot (PSA Group) and Lockheed Martin. What does VOLTA offer large organizations?

A: Nicolich: Our solutions, which scale based on the customer's needs, are consolidated around six technology pillars: automation and integration, optimization-driven design, robust design and reliability, simulation data management, engineering data intelligence, and distributed execution.

Large organizations benefit from our solutions to formalize workflows, break silos and create a common repository for sharing knowledge and best practices on a global scale and among departments, all while being fully compliant with security and data protection policies.

For engineers, ESTECO technologies translate into a better organized and more efficient environment for simulation and optimization, together with the possibility to trace and version all the steps of the process. For managers, it means easier and simpler access to results and more informed, faster decision making. All this translates into shorter

time-to-market and better products. In other words, from the point of view both of individual engineers and of large scale organizations, we provide our end users with all they need to tackle the challenges related to designing the products of tomorrow.

Q: Engineers today are facing increasing product complexity and shorter time-to-market, while having to deal with huge amounts of simulation data. How does ESTECO technology respond to these challenges?

A: Nicolich: Essentially, we are moving beyond just providing functionalities, relying more and more heavily on artificial intelligence and machine learning. This is exactly what our Engineering Data Intelligence is about. Our technology will increasingly be able to propose solutions before you ask for them, by mining large amounts of simulation data and suggesting patterns. The way this data is presented will progressively reduce the amount of know-how necessary for the fruition of our technology. Our sophisticated algorithms like pilOPT are able to understand the problem at hand and guide the user towards the right choice. We are no longer talking about a functionality or a tool, but about an 'advisor' that helps the end user make the right decisions.

Esteco is Sponsor of the
International CAE Conference 2018

www.caeconference.com

EnginSoft USA, LLC is new distributor partner of FunctionBay, Inc. in North America

Alliance ensures availability of best-in-class engineering software and services in the field of multi-body dynamics

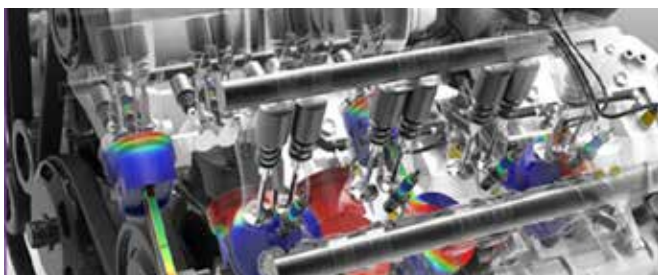

McKinney, TX – FunctionBay, Inc. has appointed EnginSoft USA, LLC as its new distributor for FunctionBay,s products in North America. The agreement includes distribution of RecurDyn software and customized tools running within. As EnginSoft USA is connected with RecurDyn Europe GmbH network, customers of North America will benefit of qualified support, engineering services, and high value solutions coming from 30 years of experience in multi-body dynamics simulation.

RecurDyn is an interdisciplinary, computer-aided engineering (CAE) software package, whose primary function is the simulation of multibody dynamics (MBD). RecurDyn simulates both rigid and flexible body dynamics by combining traditional rigid MBD with cutting-edge finite element technology for modeling flexible bodies. It also supports co-simulation with various other computer-aided engineering software tools. EnginSoft USA will strongly increases the presence of RecurDyn software in the North America's CAE market. The goal is to establish a network of sales and support personnel, to be in close proximity to the customers.

Recurdyn is Sponsor of the
International CAE Conference 2018

www.caeconference.com



Global competition for engineering students to design a hybrid microgrid:

3rd ESTECO Academy Design Competition, in collaboration with Cummins, calls for entries



Students of engineering and applied science departments worldwide can enter the 3rd edition of the ESTECO Academy Design Competition, organized in collaboration with Cummins. This year's challenge is to design a hybrid microgrid that uses both conventional and renewable energy sources.

The ESTECO Academy was established in 2015 and is a membership program which provides access to ESTECO modeFRONTIER software, dedicated online and offline training sessions and materials, certification exams, and complementary seminars and events. It is open to professors, researchers and students.

Every two years, the ESTECO Academy holds a worldwide Design Competition in collaboration with leading international organizations: illycaffè' collaborated on the first edition, while Aprilia Racing collaborated on the second. This year's edition, organized in cooperation with Cummins, was launched in May 2018 during the ESTECO International Users' Meeting (UM18). It challenges the entrants to design a hybrid microgrid that uses both conventional and renewable energy sources to supply energy to a community.

The entries should be innovative and should demonstrate the use of the modeFRONTIER optimization platform. The jury will favor designs which lead to significant improvements in energy usage and sustainability, and the competition will award the most innovative solutions, compared to traditional solutions and/or solutions already available in the open technical and scientific literature.

"Our objective is to provide tomorrow's engineers with our best-in-class technology and hands-on experience to enhance their future careers. The ESTECO Academy Design Competition is an excellent opportunity for engineering students from around the world to apply their knowledge and test their optimization skills on a real-world problem using ESTECO technology integrated with leading simulation tools," said Enrico Nobile, Scientific Advisor at ESTECO and Professor of Thermal Fluids at the University of Trieste, Italy.

"The use of optimization tools is becoming more and more mandatory when it comes to doing good design through optimization," said Kevin Brittain, MDO Group Leader at Cummins. "We wanted to challenge the students with this really interesting optimization problem that asks them to consider how to deliver reliable energy utilizing diesel gensets, gas gensets and renewable energies."

The top teams will receive a cash prize and a one-year ESTECO Academy membership for each team member. The members of the top three teams will also have the opportunity to have their curriculum vitae considered for an internship at a Cummins site worldwide.

The deadline for team registration is 16 December 2018 and final projects should be submitted no later than 30 May 2019. The winners will be announced in September 2019.

For more information visit:
academy.esteco.com/competition

Shortlist published for the soon-to-be-established Italian Highly-Specialized Competence Centers for Industry 4.0

EnginSoft to participate in 3 Competence Centers as technology provider for digital twin, advanced and multi-domain simulation, data analysis and simulation

In January 2018, the Italian Ministry of Economic Development announced a €40-million initiative to create the Italian Highly-Specialized Competence Centers as part of the new national Industry 4.0 Plan, "Piano Industria 4.0".

These Highly-Specialized Competence Centers will be composed of aggregations of universities, research centers, technology providers and enterprises that will support Italian small- and medium-sized enterprises (SMEs) to implement a digital transformation, in line with the Italian government's recommendations in its Industry 4.0 Plan. Their first objective will be to provide guidance and tools, particularly to SMEs, to assess and improve their own "digital state", after which they will provide training, both in classrooms and in companies to disseminate Industry 4.0 skills and to highlight their impact on company operating costs and for increasing product and service competitiveness. The ultimate goal is for these Centers to work side-by-side with businesses and develop industrial innovation projects in order to ensure technology transfer. In addition, these Highly Specialized Competence Centers will collaborate tightly with the actual Digital Innovation Hubs in the territory, these being the bridge to industry demand by means of their networking, matchmaking and brokerage activities.

Eight Italian Universities, plus the Italian National Research Council, submitted their proposals for establishing these Highly-Specialized Competence Centers in Italy. After the initial evaluation, the short-list of candidates was published at the end of May 2018. The Ministry of Economic Development invited all the short-listed candidate projects representatives to the negotiation phase where they have been requested to review their proposals in order to globally achieve the objectives envisaged in the Italian national Industry 4.0 Plan. Final proposals resubmission will be done by the end of the year. The winning ones will be granted funding to implement their projects.

EnginSoft will participate in three of the Highly-Specialized Competence Centers – one with the Politecnico Milan University, another with Padua University and a third with Naples' "Federico II" University. Thanks to its competencies with Digital Twins, in Advanced and Multi-domain Simulation, Data Analytics and Optimization, EnginSoft will act as a Technology Provider in the three Centers.

For more information:
Carla Baldasso - EnginSoft
c.baldasso@enginsoft.com



Tolerance Management Sector sees creation of TTC³ GmbH “2.0”



Competence Centre Tolerance management

With effect from 1 September 2018, Variation Systems Analysis GmbH and TTC³ GmbH® will merge into “the new” TTC³ GmbH®.

TTC³ GmbH® “2.0” has been created to function as a full service provider for tolerance management activities, and to provide Geometric Dimensioning and Tolerancing (GD&T) training courses, multiple software sales and technical support.

Variation Systems Analysis first began in 1996 as “VSA Deutschland GmbH”, providing a CATIA V4 integrated solution focused initially on the application of the Body in White stage of automobile manufacturing. The years between 1998 and 2000 saw a series of mergers and acquisitions after which, in 2001, the team decided to do a management buy-out and form “Variation Systems Analysis GmbH®”. In 2009, Variation Systems Analysis was certified by the German CERTQUA Organization as a GD&T Training Institute.

TTC³ GmbH® was initially founded in 2003 as a multi-product company with a best-in-class approach to tolerance management in various industry segments. Over and above its automotive applications, the company’s proven project experience in houseware, electrical power

tools, and medical, aerospace and military applications, has seen it serve more than 500 customers to date.

To catalyze the European sales activities in tolerance management and simulation, we are excited to welcome back to the company Giorgio Buccilli in his new position as Product Manager. Giorgio’s history in the company and his proven sales experience will allow us to provide high-level support to customers and to develop local markets.

Tolerance management is becoming increasingly important as more manufacturers move into the Industry 4.0 era. It has a cross-functional aspect across Industry 4.0 and Systems Engineering and TTC3 will demonstrate and prove this in show- and use-cases in order to leverage and establish PLQ® into these markets.

With Michael Kellers, responsible for Products, and Florian Weidenhiller, responsible for Methods and Services, the Tolerance Technology Competence Centre will continue to provide first-class support for customers to grow tolerance management as part of the local and global EnginSoft portfolio.

For more information, contact TTC3 GmbH at info@ttc3.com or visit the website www.ttc3.com

Flownex Europe to launch at the 2018 International CAE Conference



JV between M-Tech Industrial and EnginSoft creates Master Distributor for Flownex sales and support in Europe

South African company M-Tech Industrial (Pty) Ltd, and international premier consulting firm in Simulation Based Engineering Science (SBES), EnginSoft Spa, have signed a Memorandum of Understanding (MOU) to create Flownex Europe. The joint-venture company will be based in Cologne, Germany and will be the Master Distributor for the Flownex® product suite in Europe. The legal process is underway and Flownex Europe will be launched at the 2018 International CAE Conference in October. The new company will be headed by Luke Davidson of M-Tech Industrial and Juergen Hasselbeck of EnginSoft GmbH as the designated joint Managing Directors and will provide a hybrid sales and support network to the local markets. Flownex Europe will be staffed by a team with technical sales experience and proven business experience in a global distributed sales and marketing network.

The company’s hybrid network will include existing competent Flownex resellers as well as the different local EnginSoft sales organizations, Flownex Europe’s network business model is open to expansion.

The Flownex product supports simulation at the system level in the early design stage and offers direct integration into the

ANSYS® environment, supporting a 1D/3D two-direction integration for CFD and for mechanical applications. Flownex Europe is expected to strongly influence future software enhancements based on its close customer relationships, native-language technical support and its expertise in balancing technical enhancements with the general needs of the European market.

The new JV company will provide a technical application support centre through a joint structure created with M-Tech in South Africa to deliver proven technical expertise to support the product suite. Sales partners can draw on the company’s proven experience with sales tools, partner guidelines, marketing campaigns and success stories.

Flownex Europe’s headquarters will be at: Augustinusstrasse 11c, 50226 Frechen Koenigsdorf, Germany (Cologne).

Flownex is Sponsor of the International CAE Conference 2018

www.caeconference.com



The joint EnginSoft/PSRE team at their ACHEMA 2018 booth

Successful joint PSRE-EnginSoft booth at global process industry expo ACHEMA 2018



Attracting chemical, process and mechanical engineers from all over the world, the largest event for the process industry, the ACHEMA 2018 Exhibition, was held in Frankfurt, Germany this June. EnginSoft Spa and PSRE Co. presented their respective software and engineering services at a joint booth at the exhibition, which happens every 3 years. This year's event, attended by about 145,000 visitors from more than 100 countries, was held in 16 huge halls of the Frankfurt Messe that covered a total area of 132,000 m² and contained 3,737 exhibitors from 55 countries across all aspects of process industry: new processes and products in chemical, pharma and bio technology, mechanical and thermal equipment, plant and process control and logistics, and all kinds of engineering and simulation services.

The EnginSoft-PSRE booth was in Special Hall 9.2 which was dedicated to CAD/CAE software, research and innovation, and engineering services. Together with EnginSoft and PSRE, other exhibitors included international CAD/CAE software developers such as Autodesk, AVEVA, ProSim and others, universities, and leading Engineering, Procurement and Construction (EPC) companies.

The software part of the fair was quite strong with all kinds of graphical and simulation programs for chemical plant design being demonstrated. The software included process simulators (ProSimPlus by ProSim, ChemCAD by Chemstation, gPROM by PSE) and chemical equipment analysis (HTRI for heat exchangers for example), general CAD platforms (AutoCAD, MicroStation, Solidworks, etc), and special Piping and Instrumentation Diagrams (P&ID) and Plant 3D design tools from Autodesk, AVEVA, Bentley Systems and others. 3D virtual reality hardware and software were everywhere. Laser scanning technology was also very popular.

EnginSoft and PSRE successfully presented a wide spectrum of analysis and sizing software for the optimal design of process plants which they developed or distribute, including:

- PASS software suite for fluid flow, thermal and stress analysis of process piping and equipment;
- ANSYS Workbench Engineering Simulation platform for general Finite Element Method (FEM) and Computational Fluid Dynamics (CFD) analysis;
- Straus7 for structural stress and heat transfer static and dynamic analysis;
- Particleworks for CFD analysis using the Moving Particle Semi-Implicit method;
- modeFRONTIER, an integration platform for multi-objective and multi-disciplinary optimization.

The two companies also jointly proposed a wide spectrum of engineering services, including: analysis, sizing, optimization and design of mechanical and thermal equipment, piping systems and process facilities.

"The joint booth at ACHEMA 2018 enabled EnginSoft and PSRE to establish many promising new contacts with potential customers and partners, as well as to meet and talk to existing partners and old friends!" stated Leonid Korelstein, VP of R&D at PSRE Co.

DatapointLabs Joins Applus+, a global testing, inspection and certification group

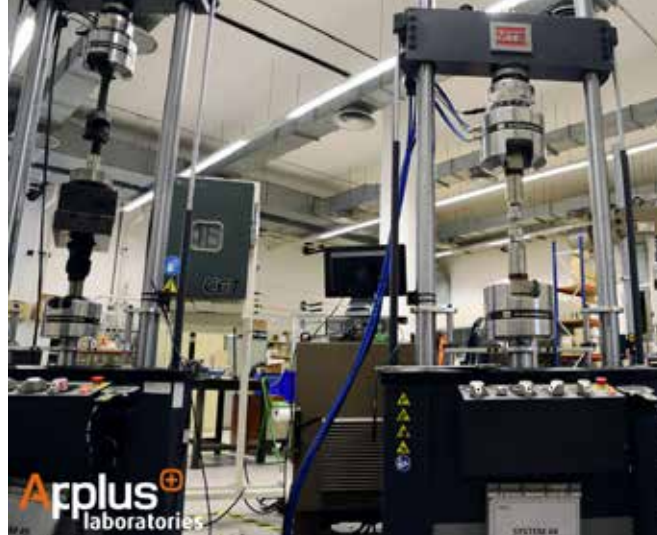

DatapointLabs Technical Center for Materials has joined Applus+, and now forms part of an international network of laboratories that provides a wide range of services to various industrial sectors, including aerospace, automotive, electronics, information technologies, and oil and gas.

For more than two decades, DatapointLabs has helped its customers to convert materials test results into data that can be used to facilitate interaction with materials information across the product life cycle. Joining Applus+ will further allow DatapointLabs to expand its testing catalog, thanks to synergies with other Applus+ materials laboratories.

Providing materials input for today's simulation-driven product development environment

DatapointLabs' expert material testing services provide accurately measured physical properties for the actual material to be used and also considers the intended manufacturing process to be used. Advanced testing and measurement techniques may be required to capture data for crash and drop simulations, for modeling the behavior of complex materials such as rubbers or foams, or for assessing creep, fatigue and other long-term behaviors.

Once the right data is acquired, it must be inserted into a numerical model that is most appropriate for calculating the effects to be simulated. The raw data needs to be correctly converted into model parameters, and the materials file needs to be complete and formatted correctly to run in the intended simulation program. DatapointLabs' TestPaks® have been specially developed to deliver the testing and inputs required for specific materials models and CAE solvers.

To understand the effects of variables such as solver fidelity, choice of material model, material data quality, and parameter conversion, it may be desirable to perform a validation of the simulation using carefully controlled physical tests that can be simulated with precision. CAETestBench™ validations use standardized parts containing geometric features that probe the accuracy of the simulation. The validation results, including measured data and simulation results, are delivered via the PicSci™ electronic lab notebook platform.

DatapointLabs' Matereality® software and infrastructure for materials provides a collective view of the required data as a whole. The data must be uniform, controlled and traceable, readily accessible, and usable by simulation solvers and other external processes that require materials information; ideally it should also be supported by an enterprise-wide materials knowledge core.

With accurate data about materials properties, as well as properly evaluated and well matched material models, the objective of achieving an accurate simulation becomes much more feasible.

About Applus+ Laboratories

Applus+ Laboratories is one of the divisions of the Applus+ group. It manages a network of multi-technological testing facilities (Materials, Structures, NDT, EMC, Radio, Environmental, Fire, and IT security, amongst others) in Europe, the USA and Asia. The division partners with leading industries such as Aerospace, Automotive, Information Technologies, Electronics, and Oil & Gas, among others. The division's experience in testing and its state-of-the-art laboratories allow it to participate throughout the entire product value chain, offering testing, engineering, quality control and certification services. In the field of materials, Applus+ has a network of laboratories in Europe and China specialized in characterization tests and quality control for metallic and composite materials.

www.appluslaboratories.com

About DatapointLabs Technical Center for Materials

Since 1995, DatapointLabs Technical Center for Materials has focused on strengthening the materials core of manufacturing enterprises. Today, its affiliated brands encompass expert material properties testing, generation of material parameters for CAE and FEA, and material model validation; as well as data infrastructures and software for materials information management and science experiment management; and a knowledge hub dedicated to curating expert information on materials in simulation.

www.datapointlabs.com

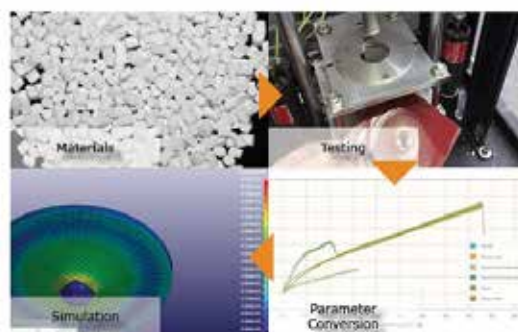

DatapointLabs
Technical Center for Materials





Open Innovation Challenge to support the adoption of Computer-Aided Engineering for Additive Manufacturing

Additive manufacturing and the ProM Facility

The number of additive manufacturing technologies and solution providers has surged over recent years. However, the know-how to implement these technologies within existing industrial processes is still being developed, especially within Small to Medium-sized Enterprises (SMEs). The ProM Facility (www.promfacility.eu) is an innovation center unique in its kind, located in Rovereto (Italy), created to research, design, experiment with and produce innovative and more efficient products that combine traditional mechanics with the most modern and sophisticated virtual prototyping and electronic control systems. Covering 2,500 square meters within the “Polo Meccatronica”, and equipped with top-notch machinery valued at €6-million, the ProM Facility allows prototyping and developing times to be significantly shortened and enables engineers to work with many technologies such as additive manufacturing, hybrid manufacturing, 3D scanning inspection and laser cutting. The ProM Facility is the result of a collaboration between the Autonomous Province of Trento, Trentino Sviluppo, Fondazione Bruno Kessler, the University of Trento and Confindustria Trento, and is supported by the European Regional Development Fund (2014-2020).

The relevance of Computer-Aided Engineering (CAE)

To realize the value of additive technology, and to better exploit the design freedom it provides, manufacturing companies need to update their

new product development processes. An agile and rapid approach to prototyping has become vital today, and CAE is already widely used to optimize the design of products and industrial components. Performing high-level Finite Element Analysis (FEA) is crucial for companies that wish to improve product performance, or save on raw materials or production costs. However, most SME manufacturers are still in the process of discovering and understanding the business potential of this approach. To facilitate this shift, the PROTO Challenge was designed to help SMEs explore the benefits of CAE for additive manufacturing technologies within a low-risk setting, in the short term, and with actionable outputs.

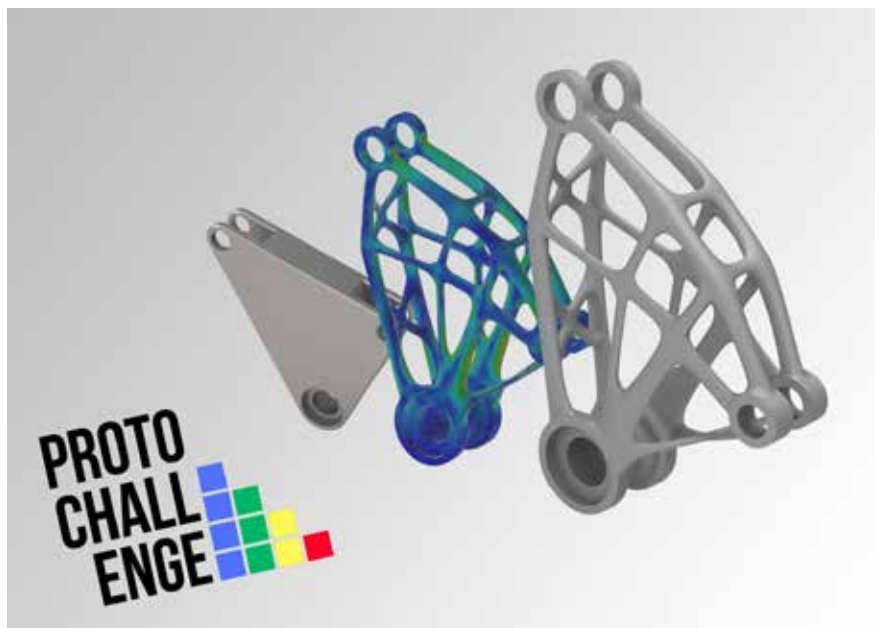

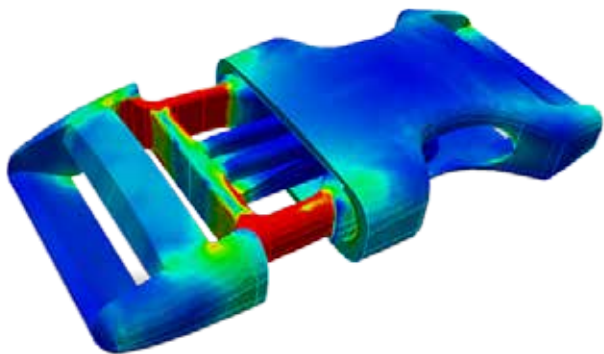
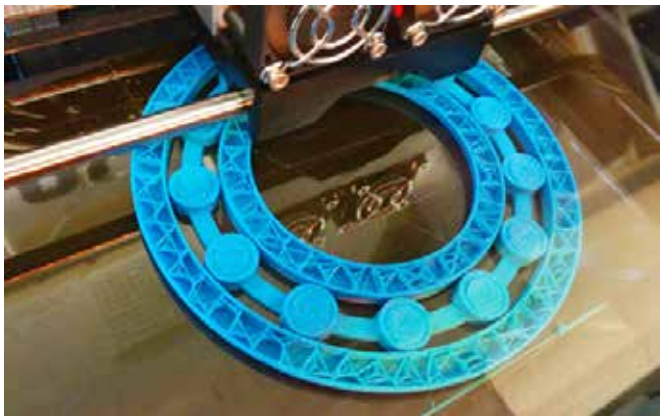

The PROTO Challenge

The PROTO Challenge is a five-week, open-innovation initiative promoted and managed by Hub Innovazione Trentino (HIT). It consists of involving young engineering talent in the analysis and redesign of manufacturing products and elements that are submitted by companies seeking to explore the adoption of additive manufacturing technologies.

Companies can submit an existing product or element (metallic or polymeric), along with specific redesign goals (eg. lightening, stiffening) and constraints to the Challenge. Over a period of five weeks, teams of young talent (mainly engineering students and graduates) will utilize advanced software to redesign the product to optimize it for additive manufacturing. For the 2018 edition of the PROTO Challenge, the software utilized will be ANSYS, made available by EnginSoft through a partnership with HIT.

Teams will make use of advanced optimization techniques (eg. FEA) that will allow the structural properties of the product to be enhanced while lowering its production cost, no matter what type of production technology the company intends to pursue (additive, hybrid, or traditional). The output of the challenge will be a new design option for the product, including the 3D CAD drawings.

The PROTO Challenge will kick off on 25 October 2018 and will end on 28 November 2018. Interested companies can apply to the Challenge by 17 July 2018 by filling in a short application form available at the following link: www.trentinoinnovation.eu/proto-challenge

The PROTO Challenge is organized in collaboration with the University of Trento, Trentino Sviluppo and Confindustria Trento, in the context of the regional Digital Innovation Hub, and is sponsored by EnginSoft.

Innovation challenges and open innovation

In addition to the PROTO Challenge, the Innovation to Market business unit of Hub Innovazione Trentino organizes the UX Challenge, a two-day event that allows digital companies to test and improve the User Experience of their apps and software with the help of interactive-design talents and carefully selected real users.

The Challenges are innovative initiatives aimed at supporting Open Innovation in the research industry at a regional level. The European Commission has recognized the novelty and impact of this format as experimented in Trentino, and has recently awarded HIT a Horizon 2020 project aiming at fostering peer-learning among innovation agencies in the field of open-innovation policy. HIT is a corporate consortium between the University of Trento, the Bruno Kessler Foundation, the Edmund Mach Foundation and Trentino Sviluppo. It promotes technology transfer and innovation in the Trentino region of Italy, fostering local business innovation and development through the exploitation of scientific research results. Services for innovation, and technologies developed by shareholders, can be found at <https://www.trentinoinnovation.eu/en/area/innovationmarket/>

*Nicola Doppio,
Hub Innovazione Trentino*

For more information:

Nicola Doppio, Innovation Officer, Hub Innovazione Trentino
www.trentinoinnovation.eu/PROTO-challenge/

ANSYS offers a complete simulation workflow for additive manufacturing (AM) that allows manufacturers to transition R&D efforts for metal AM into a successful manufacturing operation. Additive manufacturing (3D printing) is a technology that produces 3D parts layer by layer from a variety of materials (aluminum, steel, titanium, etc) and it has been rapidly gaining popularity as a true manufacturing process. In additive manufacturing, a digital data file is transmitted to a production machine, which translates an engineering design into a 3D-printed part. Metal-based AM processes were first developed in the 1990s and, soon after, companies launched Selective Laser Sintering (SLS) systems that could create a solid 3D structure by melting a powder, hence providing an alternative to direct, multi-stage manufacturing processes. The ANSYS AM simulation tools and EnginSoft's expertise help manufacturers to:

- Design for AM (DfAM) utilizing topology optimization and lattice structures
- Conduct design validation
- Improve build setup — with additional design features for part manufacturing, including part orientation and automatic generation of physics-based support structures
- Simulate the print process
- Explore and better understand materials

International 2018 CAE Conference to host a ReCaM Project exploitation event

Will showcase project results for Rapid Reconfiguration of Flexible Production Systems to interested stakeholders

ReCaM is a three-year project in the European Commission's Horizon 2020 programme to support the design and operation of future production systems. Its main goal is to develop and demonstrate the next generation of flexible production systems making use of reconfigurable modular production resources, associated engineering tools and control systems. The ReCaM tools aim to support capability-based reconfiguration and auto-programming of resources for a set of given product requirements to enable quick, cost-efficient set-up and the fast integration of new product variants.

Reconfigurable and flexible production systems allow manufacturers to change their logical and physical production system layout to address high production mixes with many product variants. This innovation is enabled by plug-and-produce communication protocols; intelligent mechatronic objects that can adapt on-the-fly to the

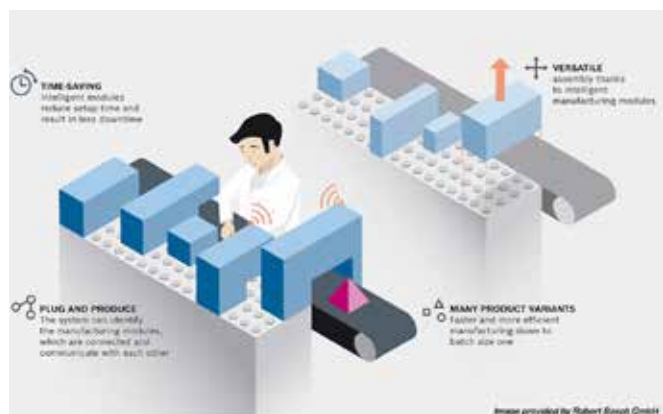

Fig. 1 - Reconfigurable and flexible production system concept (courtesy of Robert Bosch GmbH)

production request; advanced collaborative robotics; and innovative formalization, modeling, simulation and optimization methods that help companies to manage these systems and maximize the benefits.

The main benefits of the ReCaM technologies are:

- the ability to produce smaller lot sizes with a higher number of product variants with existing production systems;
- the reduction of set-up and changeover times and costs for existing production systems;
- the reduction of average energy consumption by optimizing the use of production capacity;
- strong support for the standardization of communication protocols, data structures and tool connectivity.

The event will kick off on October 9th at 9:30 with the ReCaM concept and vision presentation by the project coordinator, Sebastian Schröck of Robert Bosch Corporate Research. Subsequently, Tullio Tollo of the Politecnico di Milano, Director of the Institute of Industrial Technologies and Automation - National Research Council (ITIA-CNR)

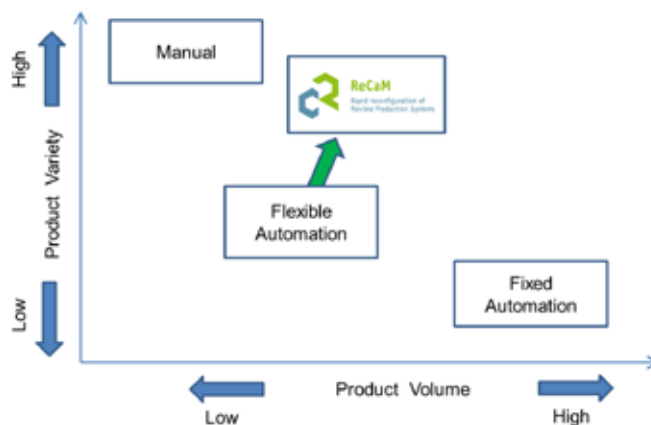

Fig. 2 - One of the clear advantages of the ReCaM approach is to decrease lot size and produce higher product variants with existing systems, while optimizing throughput and production schedules

, and President of the Italian Association of Manufacturing Technology will address specific solutions for ramp-up management in modular and reconfigurable manufacturing systems.

Afterwards, the results, methods and tools that have been created during the ReCaM project will be presented from three different perspectives: the value proposition for the end users of such technologies; the perspective of the providers of the software tools and methods; and the perspective of the systems integrators and mechatronic objects providers.

The event will close with a round table discussion on the impact and benefits of flexible production systems in the current industrial landscape, and how production is morphed by these new technologies.

Giovanni Borzi - EnginSoft
g.borzi@enginsoft.com

The ReCaM Consortium is composed of nine partners: industrial end users (Robert Bosch, CESA); technology providers (EnginSoft, Cosberg, DGH, nxtControl); and research institutions (Politecnico di Milano, Tampere University of Technology, Tecnalia)

The ReCaM project is a three-year project funded by the European Commission within the Horizon 2020 programme's "Factories of the Future (FoF-11-2015)" initiative, Grant agreement No: 680759



ANSYS[®]

POWERING INNOVATION THROUGH **ENGINEERING** SIMULATION

“ AT TIME, ANSYS STRUCTURES AND ANSYS 3D DESIGN SOLUTIONS ALLOWED GREATER ENGINEERING INSIGHT AND REDUCED FORK VIBRATION BY 30% ”

INCREDIBLE THINGS HAPPEN WHEN
CREATIVITY AND TECHNOLOGY CONVERGE

ANSYS.COM

